



CATALOGO PRODOTTI 2023-2024



GKIT-0135-QC  
ISO 9001:2015

## STORIA DI UN MARCHIO, REALTA' DI UN PRODOTTO

- 1948** Le Acciaierie e Ferriere Lombarde Falck, leader italiano nella produzione di nastri d'acciaio legato e ad alto carbonio, nell'ambito di un processo di verticalizzazione aziendale danno vita ad una realtà produttiva che si caratterizza per la fabbricazione di sezioni di lama destinate alle macchine falciatrici e mietitrebbia. Nasce il marchio STELLA.  
Le lame STELLA in breve tempo acquistano notorietà diventando sul mercato italiano sinonimo di qualità.
- 1995** La nuova proprietà guidata dall'Ing. Alfredo Tricomi rileva il ramo d'azienda e avvia un programma di potenziamento delle linee produttive e della gamma prodotti.  
Inizia la crescita internazionale di Stella.
- 1996** STELLA viene trasferita nell'attuale Headquarter di Cellatica, alle porte di Brescia, Italia.
- 2008** I sistemi di taglio Stella festeggiano i loro primi 60 anni sul mercato.
- 2023** STELLA, leader in Italia, continua la sua espansione sui principali mercati internazionali grazie all'ampliamento della gamma prodotti e al costante orientamento alla qualità totale.

***Lame Stella - 75 anni di qualità totale***



## **INDICE PRODOTTI**

<b>Sezioni di lame falciatrici .....</b>	<b>01</b>
<b>Sezioni di lame mietitrebbia .....</b>	<b>07</b>
<b>Lame per viticoltura e per cimatrici.....</b>	<b>13</b>
<b>Lame per biotrituratori .....</b>	<b>17</b>
<b>Coltelli per falciatrici rotative .....</b>	<b>19</b>
<b>Viti, dadi e bulloni .....</b>	<b>31</b>
<b>Coltelli trinciapaglia &amp; boccole .....</b>	<b>33</b>
<b>Coltelli trinciastocchi / Coltelli testata mais .....</b>	<b>43</b>
<b>Lame Kemper .....</b>	<b>49</b>
<b>Coltelli per canna da zucchero .....</b>	<b>55</b>
<b>Lame per carri desilatori .....</b>	<b>57</b>
<b>Coltelli per rotopresse / autocaricanti.....</b>	<b>73</b>
<b>Piastrine di pulizia .....</b>	<b>85</b>
<b>Lame per decespugliatori .....</b>	<b>87</b>
<b>Kit lame per robot automatici .....</b>	<b>89</b>
<b>Lame complete Stella per falciatrici .....</b>	<b>91</b>
<b>Lame complete Stella per mietitrebbia .....</b>	<b>95</b>
<b>Denti per mietitrebbia e falciatrici.....</b>	<b>99</b>
<b>Lame speciali</b>	



## LEGENDA



- L** liscia naturale
- LL** liscia spianata
- S** sotto rigata
- SR** sopra rigata
- F** con finestra
- SV** svasatura fori sopra
- SVS** svasatura fori sotto
- CR** cromatura
- P** piegata
- Zn** zincata

Le misure sulle lame sono espresse in millimetri



- L** Klinge glatt
- LL** Klinge glatt abgeschrägt
- S** Klinge u. gezahnt
- SR** Klinge o. gezahnt
- F** Mit Schlitzloch
- SV** Klinge oben versenkt
- SVS** Klinge unten versenkt
- CR** Verchromt
- P** Gefaltet
- Zn** Verzinkung

Die Maße der Klingen sind in millimeters



- L** liso natural
- LL** liso
- S** bajo dentada
- SR** superior dentada
- F** con la apertura
- SV** agujeros hasta avellanado
- SVS** agujeros por avellanado
- CR** cromado
- P** doblado
- Zn** galvanizado

Las medidas indicadas en las hojas están en milímetros



- L** regular
- LL** smooth
- S** under serrated
- SR** top serrated
- F** with opening
- SV** holes up countersink
- SVS** holes down countersink
- CR** chrome plated
- P** bendet
- Zn** galvanized

The measures on the blade are in millimeters



- L** section lisse
- LL** lisse nivelée
- S** fauc. dessous
- SR** fauc. dessus
- F** avec fenetre
- SV** trous fraisés dessus
- SVS** trous fraisés dessous
- CR** chromate
- P** plié
- Zn** zingueé

Les mesures sur les lamas son en millimètres

Le lame del presente catalogo sono adattabili alle marche indicate. I codici e le marche sono solo specificate per fini comparativi e di adattabilità.

# SEZIONI DI LAME FALCIATRICI

[www.stellalame.com](http://www.stellalame.com)



**SEZIONI DI LAME FALCIATRICI - MOWERS BLADES**  
**KLINGEN FÜR MAHMASCHINEN - SECTIONS FAUCHEUSES**  
**SECCIONES CUCHILLAS MOTOSEGADORAS - СЕГМЕНТЫ ДЛЯ КОСИЛОК**

Codice

Adattabili a:

Codice

Adattabili a:

**212 S**

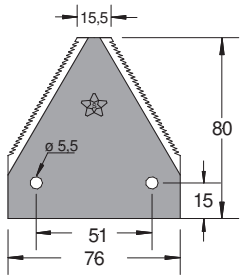

Sotto rigata  
Spess. 2 / 3

436 / 436 G / 436 Plain  
Valpadana  
D.4010  
John Deere Z7029H  
John Deere Z7030 H (sp.3)

**212 SF**

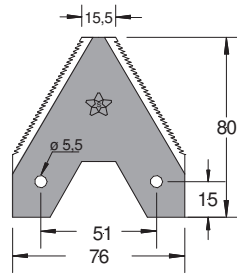

Sotto rigata  
Spess. 2

Sep  
Bcs 580 02466  
Bertolini 2091/582091  
Grillo 10642  
Nibbi 4229  
Losi / Barbieri  
Bcs 580 29866

**212 SF - h.75 sv.**

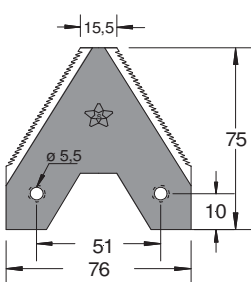

Sotto rigata  
Spess. 2  
Svas. sotto

Bcs 580 27785

**212 SF sp.3**

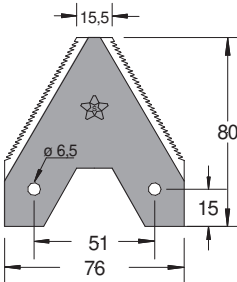

Sotto rigata  
Spess. 3

Seko  
Seko 24479005 (pieg.)  
Bertolini  
Bcs 2466/3  
Bedogni 12198  
Sep 206775  
Nibbi NB4249

**242 S**

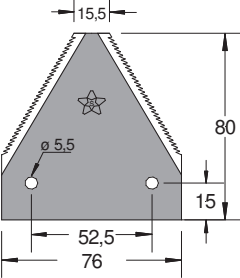

Sotto rigata  
Spess. 2

Gaspardo 443024 - 420016  
Rasspe ME333-MB333  
Laverda 340443003  
Gribaldi & Salvia 902  
(Liscia) Laverda 340443002  
(Liscia) Gribaldi & Salvia 901  
(sp.3) Rasspe M22831

**88x3 S f. 6,25 sv.**

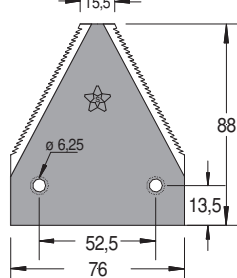

Sotto rigata  
Spess. 3  
Svas. sotto

Applicazione FB 940  
Gaspardo 21120243  
Gaspardo 3012370  
Enorossi 12880853

**88x3 S f. 5,5 sv.**

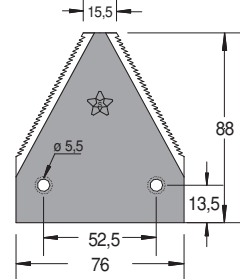

Sotto rigata  
Spess. 3  
Svas. sotto

Applicazione FB 925  
Gaspardo 21120065  
Gaspardo 158123UV  
(Non svas.) Gaspardo 3010030

**89x3 S f. 5,5 sv.**

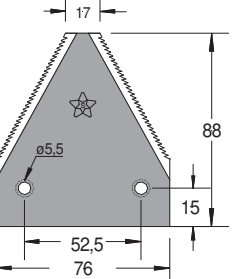

Sotto rigata  
Spess. 3  
Svasata

Applicazione G&S 394-402  
(sv. sopra) Gribaldi & Salvia 036  
(sv. sotto) Gribaldi & Salvia 14670

**89x3 S f.5,5 3F**

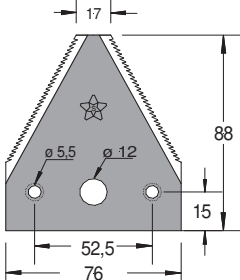

Sotto rigata  
Spess. 3  
Svas. sotto

Applicazione G&S 394-402  
Gribaldi & Salvia 14672

**89x3 SF**

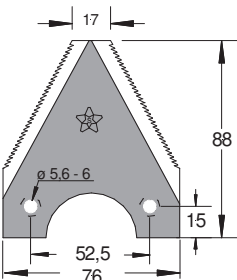

Sotto rigata  
Spess. 3  
Svas. sotto

I.M.A. La rocca



**SEZIONI DI LAME FALCIATRICI - MOWERS BLADES**  
**KLINGEN FÜR MAHMASCHINEN - SECTIONS FAUCHEUSES**  
**SECCIONES CUCHILLAS MOTOSEGADORAS - СЕГМЕНТЫ ДЛЯ КОСИЛОК**

Codice

Adattabili a:

Codice

Adattabili a:

**DIN 75**

Liscia / Sotto rigata  
Spess. 2

Fortschritt 4105.000.99.8 (S)  
Stockey & Schmits 100.22.14  
Aebi

**DIN 80 S - 222 S**

Sotto rigata  
Spess. 2

D.Fahr - Kuhn - Steir  
Aebi - Reform - Bucher  
Rapid 22222  
Rasspe RS7500 R  
Gaspardo 20800064  
(liscia) Rasspe RS7500  
(liscia) Gaspardo 20800065

**DIN 80 5 fori**

Sotto rigata / liscia  
Spess. 2 / 3

Rapid D304

**27096 S sv.**

Sotto rigata  
Spess. 2  
Svas. sotto

Bcs 580 27096

**28096 S sv.**

Sotto rigata  
Spess. 2,5  
Svas. sotto

Bcs 580 28096

**59014 S sv.**

Sotto rigata  
Spess. 2

Bcs 580 59014

**D2001 S**

Sotto rigata  
Spess. 2,5

Bcs 580 48945  
Benassi  
Barbieri  
Bertolini  
Losi

**D2001 S h.74 sv.**

Sotto rigata  
Spess. 2,5  
Svas. sotto

**D2002 S**

Sotto rigata  
Spess. 2,5

Cavalli 3516

**D2002 S h.74 sv.**

Sotto rigata  
Spess. 2,5  
Svas. sotto



**SEZIONI DI LAME FALCIATRICI - MOWERS BLADES**  
**KLINGEN FÜR MAHMASCHINEN - SECTIONS FAUCHEUSES**  
**SECCIONES CUCHILLAS MOTOSEGADORAS - СЕГМЕНТЫ ДЛЯ КОСИЛОК**

Codice

Adattabili a:

Codice

Adattabili a:

**3550 S sv.**

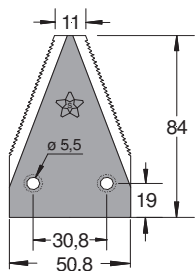

Sotto rigata  
Spess. 3  
Svas. sotto

Cavalli

**2148 S**

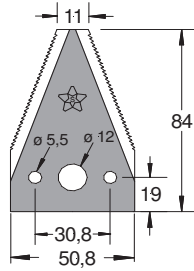

Sotto rigata  
Spess. 2,5

Cavalli

**50696 S sv.**

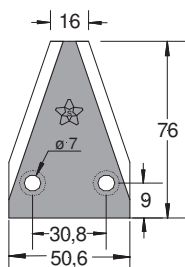

Sotto rigata  
Spess. 2,5  
Svas. sotto

Bcs

563 50696

**50684 LL sv.**

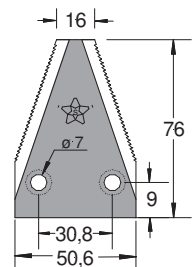

Liscia  
Spess. 2,5  
Svas. sotto

Bcs

563 50684

**59015 S sv.**

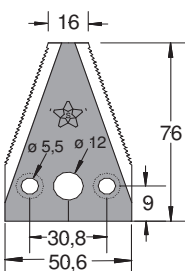

Sotto rigata  
Spess. 2,5  
Svas. sotto

Eurosystems 26102005/1

Bcs

563 59015

**59016 LL sv.**

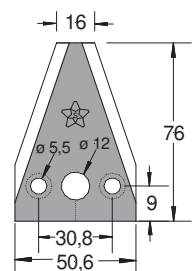

Liscia  
Spess. 2,5  
Svas. sotto

Bcs

563 59016

**58716 S**

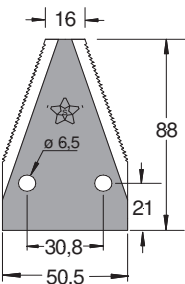

Sotto rigata  
Spess. 2,5



Bcs

563 58716

BCS 563 58761 (senza alleggerimento)

**85315 S**

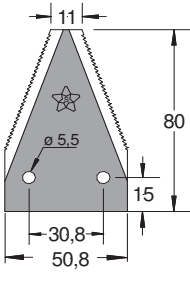

Sotto Rigata  
Spess. 2

Fort

Bcs 580 48945

**85316 LL**

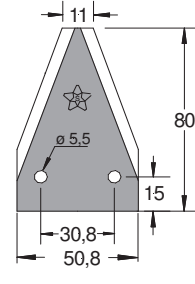

Liscia  
Spess. 2

Fort

**ST 7000 f.6,25 sv. sopra**

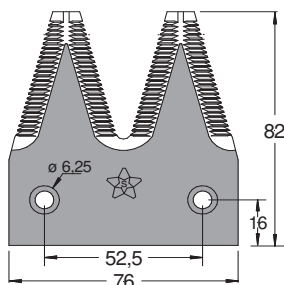

Sopra rigata  
Spess. 2,7  
Svasata sopra



Gaspardo

13013540

**ST 7000 f.6,25 sv. sotto**

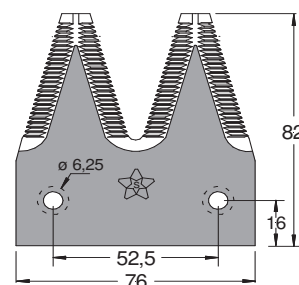

Sopra rigata  
Spess. 2,7  
Svasata sotto



Gaspardo

13013550





**SEZIONI DI LAME FALCIATRICI - MOWERS BLADES**  
**KLINGEN FÜR MAHMASCHINEN - SECTIONS FAUCHEUSES**  
**SECCIONES CUCHILLAS MOTOSEGADORAS - СЕГМЕНТЫ ДЛЯ КОСИЛОК**

Codice

Adattabili a:

Codice

Adattabili a:

**GB 2730**

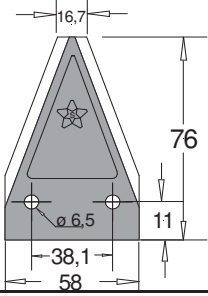

Liscia  
 Spess. 2,5  
 Svasata sotto

Busatis 580200901

**GB 2731**

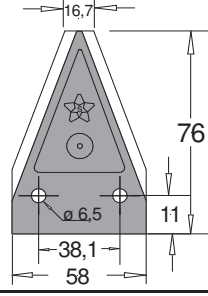

Liscia  
 Spess. 2,5  
 Svasata sotto  
 Con piolo

Busatis 580201101  
 Esm 244151

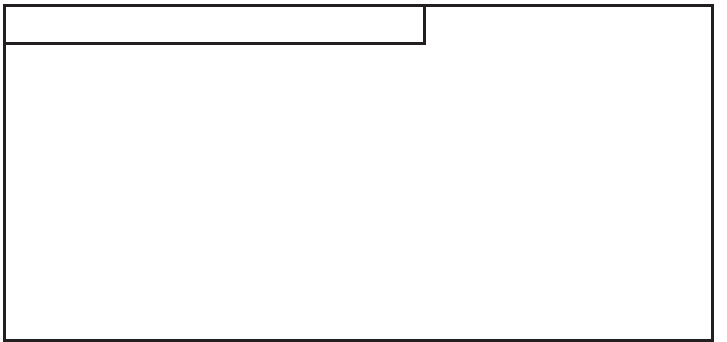
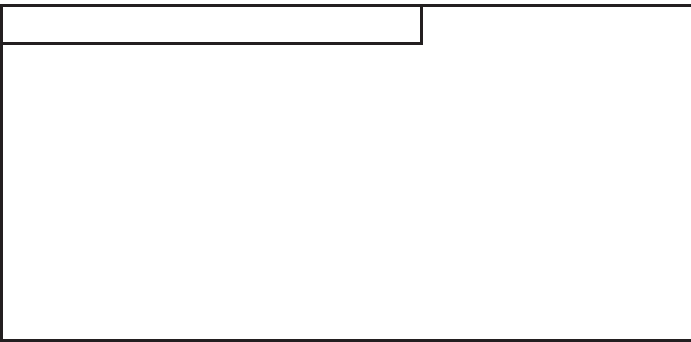
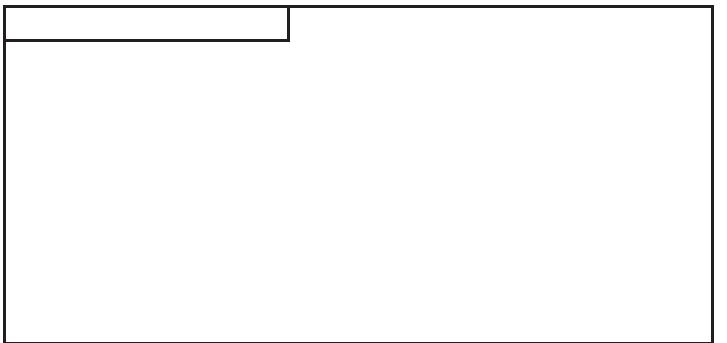
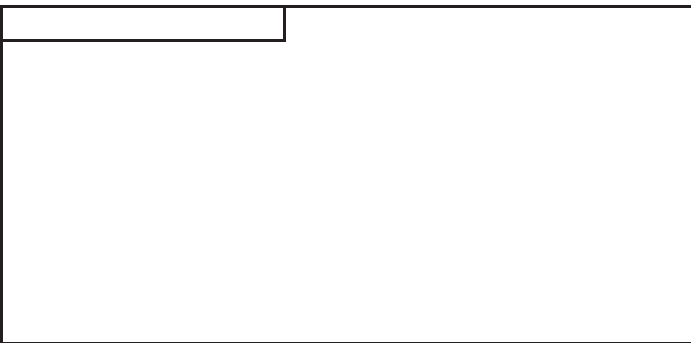
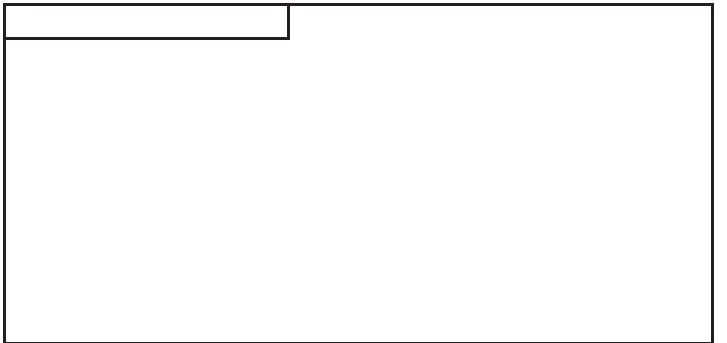
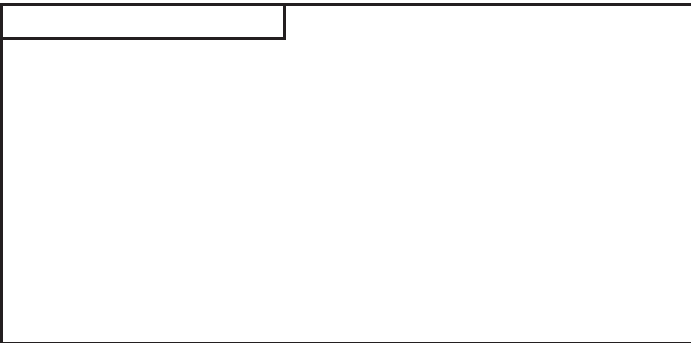
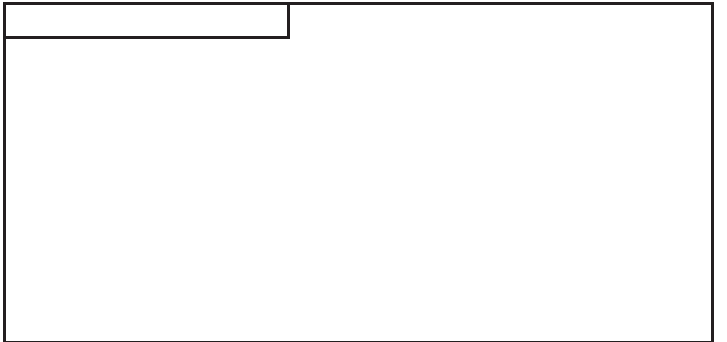
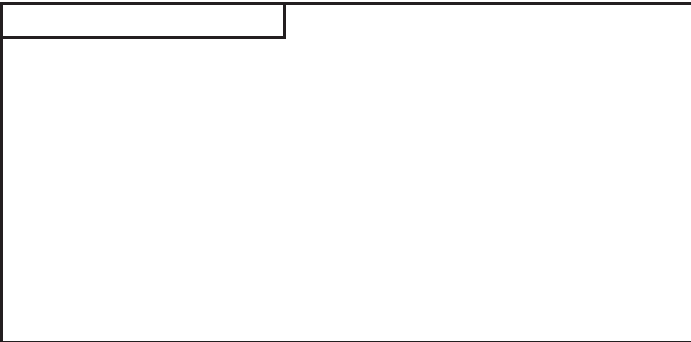

**SEZIONI DI LAME FALCIATRICI - MOWERS BLADES**  
**KLINGEN FÜR MAHMASCHINEN - SECTIONS FAUCHEUSES**  
**SECCIONES CUCHILLAS MOTOSEGADORAS - СЕГМЕНТЫ ДЛЯ КОСИЛОК**

Codice

Adattabili a:

Codice

Adattabili a:













# SEZIONI DI LAME MIETITREBBIA

[www.stellalame.com](http://www.stellalame.com)

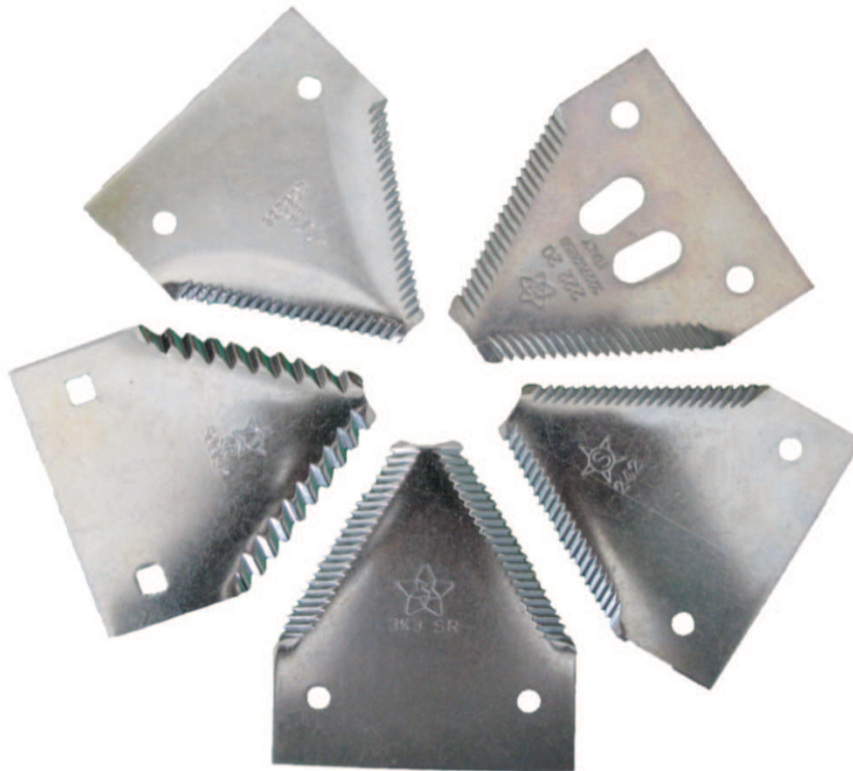

**SEZIONI DI LAME MIETTITREBBIA - COMBINE HARVESTER BLADES**  
**KLINGEN FÜR MAHDRESCHER - MOISSONNEUSES BATTEUSES**  
**SECCIONES DE COSECHADORA - СЕГМЕНТЫ ДЛЯ ЗЕРНОУБОРОЧНЫХ КОМБАЙНОВ**

Codice

Adattabili a:

Codice

Adattabili a:

**343 S**

Sotto rigata  
Spess. 3

Clyson  
New Holland 80365111

**343 SR f.6,8**

Sopra rigata  
Spess. 2,7

New Holland  
Laverda 321219850

**343 SR f.5,5**

Sopra rigata  
Spess. 2,7

Laverda 365110  
New Holland 80365110

**343 SR f.6,25**

Sopra rigata  
Spess. 2,7

New Holland 87728899  
Cnh 84429103

**242 S**

Sotto rigata  
Spess. 2

Laverda 340443003  
LF9R - 333 (MA-MB-ME)  
Rasspe ME333-MB333

**242 SR sp.2**

Sopra rigata  
Spess. 2

Hesston 49213 (soia) 049924  
Laverda 321088250  
New Holland 340443004  
Hesston 49213 (CR)  
New Holland 604921D (CR)

**P49650 H SR**

Sopra rigata  
Spess. 2,7

J.Deere P49650H  
J.Deere AZ32298

**P49650 H S**

Sotto rigata  
Spess. 2

J.Deere

**P55650 SR**

Sopra rigata  
Spess. 2,7

J.Deere P55650

**E 76370 SR**

Sopra rigata  
Spess. 2,7

(CR) J.Deere E 76370 - E 45996H



**SEZIONI DI LAME MIETTITREBBIA - COMBINE HARVESTER BLADES**  
**KLINGEN FÜR MAHDRESCHER - MOISSONNEUSES BATTEUSES**  
**SECCIONES DE COSECHADORA - СЕГМЕНТЫ ДЛЯ ЗЕРНОУБОРОЧНЫХ КОМБАЙНОВ**

Codice

Adattabili a:

Codice

Adattabili a:

**222 20**

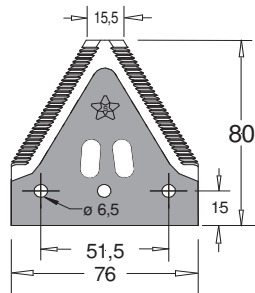

**Disponibile versione Zincata (ZN)**  
 Sopra rigata  
 Spess. 2,7  
 Sch 420100045 E28 - Sch 10961.06 (d.ti 20)  
 Sch 420100046 C23 - Sch 10966.06 (d.ti 25)  
 Sch 10978.06 (d.ti 14) - Agco 71386924  
 J.D. Z93077 (d.ti 20) - J.D. Z93078 (d.ti 25)  
 J.D. AZ52672 - AZ40032 - AZ47493  
 Deutz Fahr 16007763 - CNH 4260714246  
 Laverda 322702850 - Laverda 327840145

**222 20F**

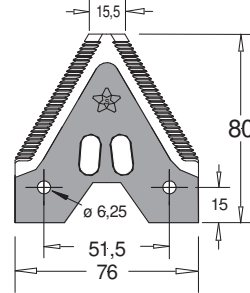

Sopra rigata  
 Spess. 2,7

J.Deere  
 Deutz Fahr

**222 U**

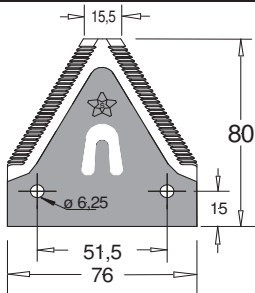

Sopra rigata  
 Spess. 2,7

Sch 420 100 015  
 J.Deere AZ 40032

**222 UF**

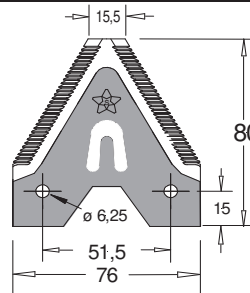

Sopra rigata  
 Spess. 2,7

J.Deere AZ 40032  
 Sch 420 100 015  
 M.D.W - Fortschritt 4260-71424-6

**222 T**

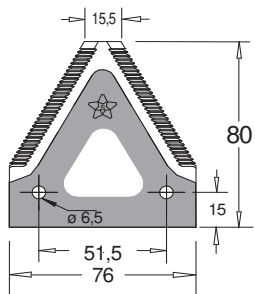

Sopra rigata  
 Spess. 2,7

Sch 10961.03  
 J.Deere Z47493  
 Sch. 420.100.001  
 Deutz Fahr 065.035.30

**DIN 80 S / L**

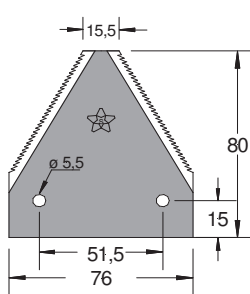

Sotto Rigata / liscia  
 Spess.2  
 Disponibile anche spessore 3

Deutz Fahr 06227771 (S)  
 Deutz Fahr 06227769 (L)  
 Claas 522187 (S)  
 Claas 522188 (L)  
 J.Deere  
 New Holland 80 420.016

**DIN 80 3SR - DIN LAND 300**

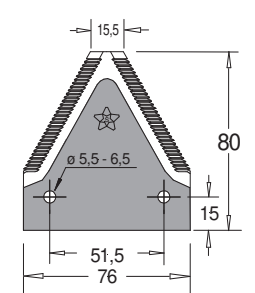

Sopra rigata  
 Spess. 2,7

Claas Din Land 300

**DIN 80 2SR**

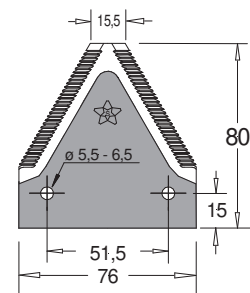

Sopra rigata  
 Spess. 2

J. Deere  
 Claas 522187  
 New Holland 80 420.019 = MZ534.062.05

**E 76371 S**

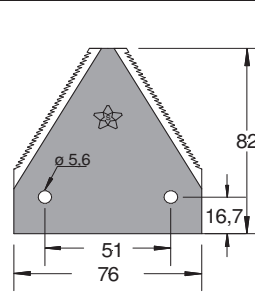

Sotto rigata  
 Spess. 3

(CR) J.Deere E 76371 - H 21530

**611318 L**

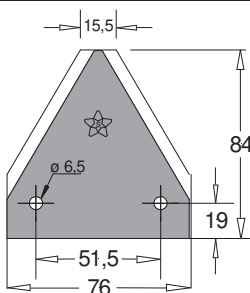

Liscia  
 Spess. 3

Claas 611318



**SEZIONI DI LAME MIETTITREBBIA - COMBINE HARVESTER BLADES**  
**KLINGEN FÜR MAHDRESCHER - MOISSONNEUSES BATTEUSES**  
**SECCIONES DE COSECHADORA - СЕГМЕНТЫ ДЛЯ ЗЕРНОУБОРОЧНЫХ КОМБАЙНОВ**

Codice

Adattabili a:

Codice

Adattabili a:

**611203.1 SR**

Sopra rigata  
Spess. 2,7

Claas 611203.1

**611316 S**

Sotto rigata  
Spess. 3

Claas 611316

**9145 S**

Sotto rigata  
Spess. 2

Arbos 59174 (f.5,5)  
Arbos 9145 (f.7,5)

**9145 SR**

Sopra rigata  
Spess. 2,7

Arbos J.Deere PK23700H

**206236 S**

Sotto rigata  
Spess. 3

Lova 20623614

**206236 SR M1H**

Sopra rigata

*Spessore 2 mm*  
Arbos 64861 (f.5,5) - 64860 (f.7,5)  
Massey Ferguson - Lova 33176117 M1

*Spessore 2,7 mm*  
Arbos 70899 (f.5,5) - 70897 (f.7,5)  
Sampo 498820

**309197 SR**

Sopra rigata  
Spess. 2,7

New Holland 80309197  
Clyson  
J.Deere H79611 - H84413  
J.Deere H125893 (Cromata)

**309197 S**

Sotto rigata  
Spess. 3

New Holland 80322481  
Clyson 322481  
Laverda 340443023  
J.Deere 84415  
Claas

**309197 SR Q**

Sopra rigata  
Spess. 2,7

New Holland 80755207  
New Holland 84998682  
New Holland 84992425  
New Holland 80755207 CR

**CA826720 C2**

Sopra rigata  
Spess. 2,7

Cnh 112074  
Case CA826720 C2



**SEZIONI DI LAME MIETTITREBBIA - COMBINE HARVESTER BLADES**  
**KLINGEN FÜR MAHDRESCHER - MOISSONNEUSES BATTEUSES**  
**SECCIONES DE COSECHADORA - СЕГМЕНТЫ ДЛЯ ЗЕРНОУБОРОЧНЫХ КОМБАЙНОВ**

Codice

Adattabili a:

Codice

Adattabili a:

**242 SR sp.3**

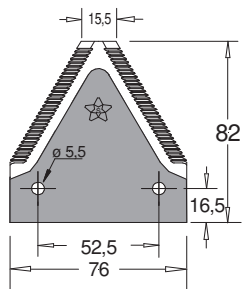

Sopra rigata  
Spess. 2,7

Cnh 49254  
Dronningborg 44100000  
Hesston 049916 = 049254  
PT / 1010  
700702966 - MC 333.5  
Hesston 049916 (CR)  
Hesston 049254 (CR)

**242 SR sp. 3 f.6,5**

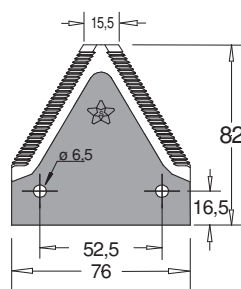

Sopra rigata  
Spess. 2,7

Dronningborg 44103700

**MCD SR**

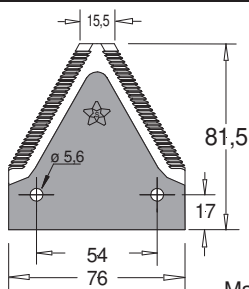

Sopra rigata  
Spess. 2,7

Mac Don 102053 (dente grosso)  
Mac Don 158516 (dente grosso)  
Mac Don 34390 (dente fine) - App. Case 87422066

**86615988 SR**

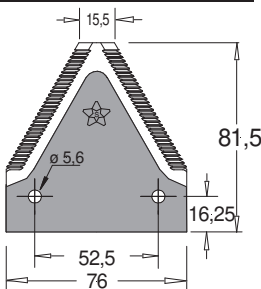

Sopra rigata  
Spess. 2,7

Cnh 86615988

**86615986 SR**

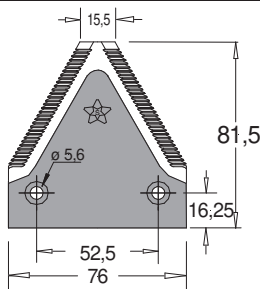

Sopra rigata  
Spess. 2,7  
sv. sopra

Cnh 86615986

**86615987 SR**

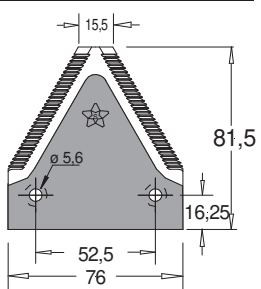

Sopra rigata  
Spess. 2,7  
sv. sotto

Cnh 86615987

**ST 7000**

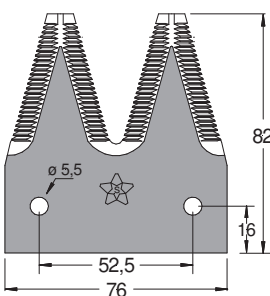

Sopra rigata  
sp. 2,7  
Disp. anche zincata

GB 7000  
Claas 650561.0  
New Holland 848093

**ST 6000**

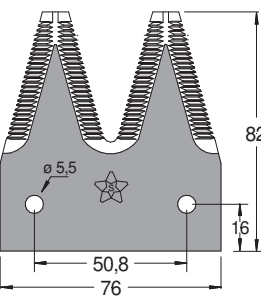

Sopra rigata  
sp. 2,7  
Disp. anche zincata

DC 6000  
GB 6000 (sv. sopra)  
Laverda 320802350 (sv. sotto)

**ST 163131**

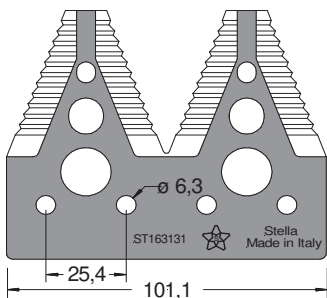

Sopra rigata  
sp. 2,7  
Dente grosso

John Deere H163131



**ST 153329**

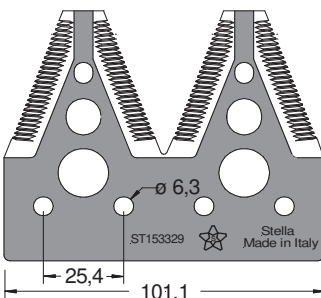

Sopra rigata  
sp. 2,7  
Dente fine

John Deere H153329



**SEZIONI DI LAME MIETTITREBBIA - COMBINE HARVESTER BLADES**  
**KLINGEN FÜR MAHDRESCHER - MOISSONNEUSES BATTEUSES**  
**SECCIONES DE COSECHADORA - СЕГМЕНТЫ ДЛЯ ЗЕРНОУБОРОЧНЫХ КОМБАЙНОВ**

Codice

Adattabili a:

Codice

Adattabili a:

**Mezza sezione**

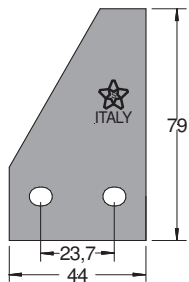

sp. 2,95

Agco-Laverda 71386923

SCH 13935.01

--

--

--

--

--

--

--

--





# LAME PER VITICOLTURA E CIMATRICI

[www.stellalame.com](http://www.stellalame.com)



NEW CUTTING UNIT  
***Testa rossa***  
*for viticulture & forest*

# NEW CUTTING UNIT

# *Testa rossa*

## *for viticulture & forest*

Testa Rossa è la nuova cutting unit di STELLA ideale per il taglio di vegetazione e secco fino a 3 cm di diametro. Disponibile in tre lunghezze standard e pronta per essere montata su ogni macchina

Modello	Codice	Lunghezza (cm)	Taglio diam (mm)	Dimens.	Numero giri (max)	Peso (Kg)	Motori Cm3*
TR 120	SLC 2110	120	25/30	122x20	350	29	50/80/100
TR 150	SLC 2120	150	25/30	152x20	350	36	50/80/100
TR 180	SLC 2130	180	25/30	182x20	350	43	50/80/100

\*Motore opzionale

Impieghi: **viticoltura, forestale e manutenzione del verde**



**LAME PER VITICOLTURA E CIMATRICI - BLADES FOR VITICULTURE**  
**KLINGEN FÜR DEN WEINBAU - SECTIONS POUR LA VITICULTURE**  
**CUCHILLAS PARA LA VITICULTURA - НОЖИ СТРИГАЛЬНЫХ МАШИН ДЛЯ ВИНОГРАДСТВА**

Codice

Adattabili a:

Codice

Adattabili a:

**89x3 S f. 5,5**

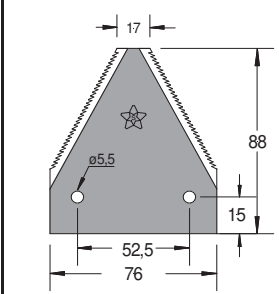

Sotto rigata  
Spess. 3

**222 20**

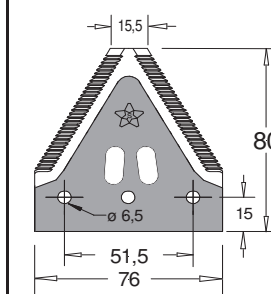

Sopra rigata  
Spess. 2,7

Disponibile versione  
Zincata (ZN)

**DIN 80 3SR - DIN LAND 300**

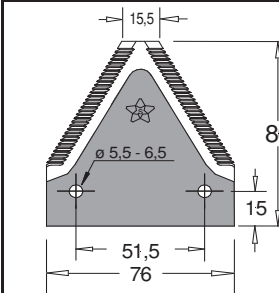

Sotto rigata  
Spess. 2,7

**FRANCIACORTA**

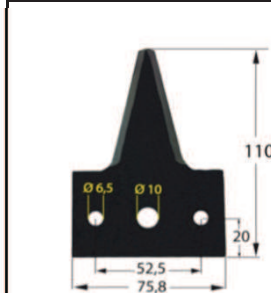

Lama  
Spess. 3  
Sv. sotto

Cavalli

**VITE ITALIANA**

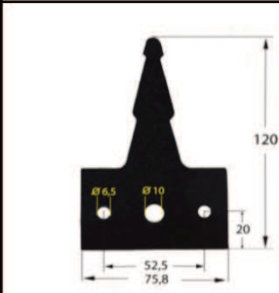

Dente  
Spess. 3  
Sv. sotto

Cavalli

**STDM 01 UNIVERSALE**



Forgiato

**NEW**

Sch 410100001

Sch 16500.01

**DM 1**



Sch 410100001

Sch 16500.01

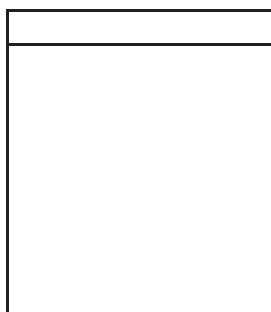
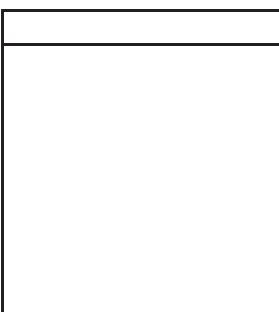

**LAME PER VITICOLTURA E CIMATRICI - BLADES FOR VITICULTURE**  
**KLINGEN FÜR DEN WEINBAU - SECTIONS POUR LA VITICULTURE**  
**CUCHILLAS PARA LA VITICULTURA - НОЖИ СТРИГАЛЬНЫХ МАШИН ДЛЯ ВИНОГРАДСТВА**

Codice

Adattabili a:

Codice

Adattabili a:













# LAME PER BIOTRITURATORI

[www.stellalame.com](http://www.stellalame.com)



**BIOTRITURATORI - BIO SHREDDER**  
**БИОНАЕКСЛЕР - БРОЙЕРС**  
**BIOTRITURADORES - НОЖИ ДЛЯ БИОИЗМЕЛЬЧИТЕЛЕЙ**

Codice

Adattabili a:

Codice

Adattabili a:

**W DIN 80**

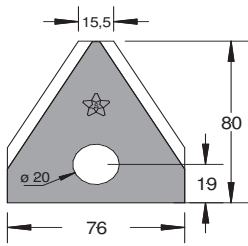

Liscia  
Spess. 2

Wagner

**222 1 F**

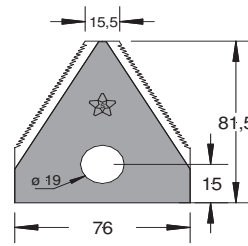

Sotto rigata  
Spess. 2 / 3

Negri

**BIO T1**

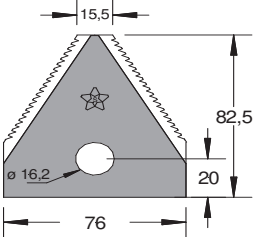

Sotto rigata  
Spess. 3

Bio Caravaggi 60-80

**BIO T2**

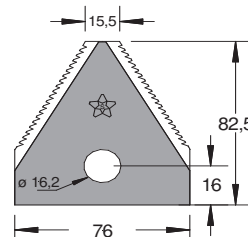

Sotto rigata  
Spess. 3

Bio Prof Caravaggi 50-150

**SG 26**

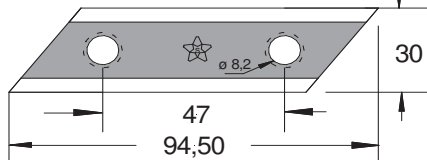

Liscia  
Spess. 3

AL-KO 325967  
Sandrigarden 261800

**SG 27**

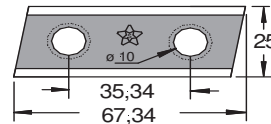

Liscia  
Spess. 2

Sandrigarden 275420

**D2001 L TA**

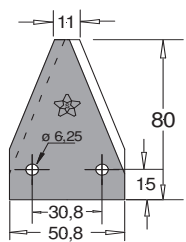

Liscia  
Spess. 2,5



# COLTELLI PER FALCIATRICI ROTATIVE

[www.stellalame.com](http://www.stellalame.com)

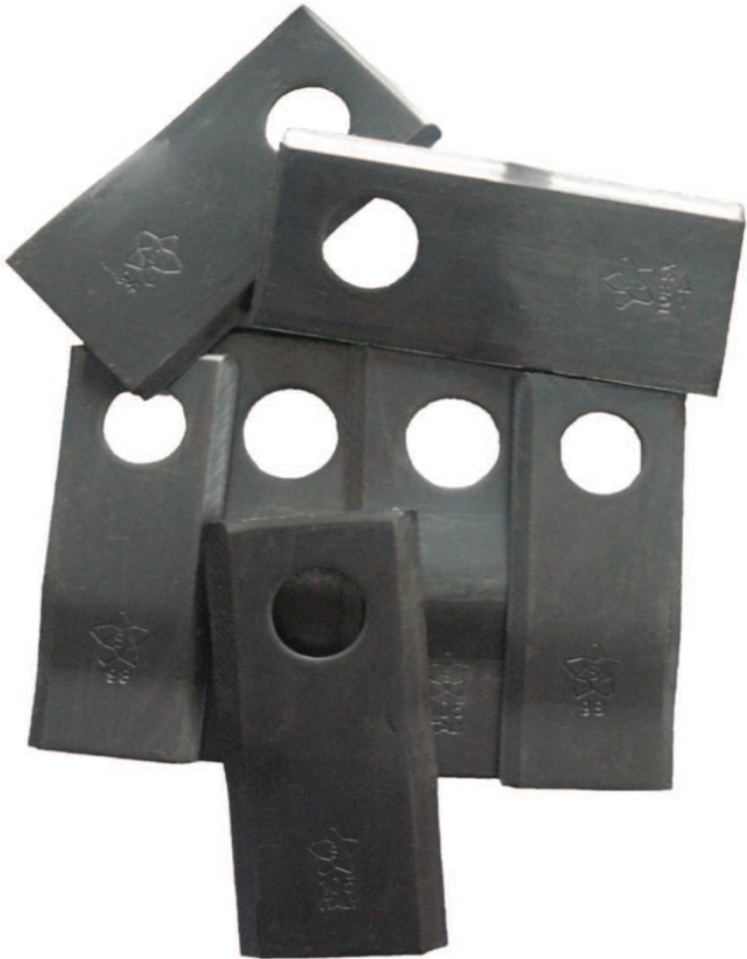

**COLTELLI PER FALCIATRICI ROTATIVE - ROTARY MOWER KNIVES**  
**ROTOR KLINGEN - COTEAUX DE FAUCHEUSES ROTATIVES**  
**CUCHILLAS PARA SEGADORAS ROTATIVAS - НОЖИ ДЛЯ РОТОРНОЙ КОСИЛКИ**

**DIRITTO - STRAIGHT**  
**GERADE - DROIT - DERECHO - Прямой**

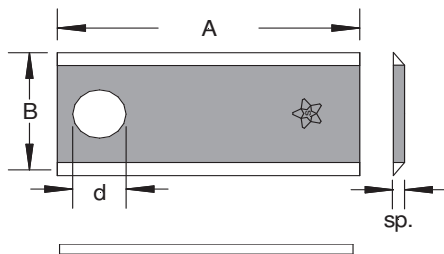

CODICE STELLA					APPLICAZIONE	ADATTABILI A ORG
	A	B	d	sp.		
D	83	40	19	3	FAHR KRONE KRONE	1.1019.010.282.00 1431490 1372 242 7
D	88	40	19	3	CLAAS FAHR FAHR FELLA GARNIER KRONE KRONE LINCE NIEMEYER PÖTTINGER RS WELGER ZWEEGERS	977.516.0 0653 1543 1-1019-010-271.20/88 477 741 4460101001 141071.0 143149.3 088 D 11.065 434992 15 01 331 0982.1501.00 MT 52
D	90	40	19	3	CLAAS FAHR FAHR (NEW) FELLA IHC IHC KRONE NIEMEYER NIEMEYER PÖTTINGER RASSPE RASSPE WELGER ZWEEGERS	977 516.0 1-1019-010-271.20/90 0656 1543 477 741 1133937 R1 3101549 R1 143 149 4 570 400 11.065 434992 1.501.331 80-10-46 0982.15.01.00 MT 52S
D	94	40	19	3	CLAAS FAHR FAHR (NEW) FARENDLOSE NIEMEYER RASSPE	978 186.0 1-1012-030-115.00 0656 1542 00.0114.054 11.079 RS 20.01.331
D	94	40	16,25	3	KUHN NEW HOLLAND NEW HOLLAND	561.500.00 549 757 274 230





**COLTELLI PER FALCIATRICI ROTATIVE - ROTARY MOWER KNIVES**  
**ROTOR KLINGEN - COTEAUX DE FAUCHEUSES ROTATIVES**  
**CUCHILLAS PARA SEGADORAS ROTATIVAS - НОЖИ ДЛЯ РОТОРНОЙ КОСИЛКИ**

**DIRITTO - STRAIGHT**  
**GERADE - DROIT - DERECHO - Прямой**

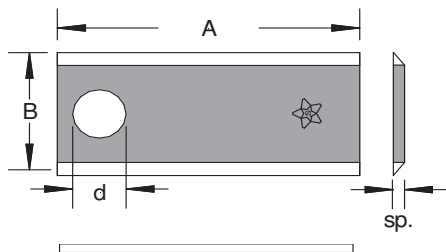

CODICE STELLA					APPLICAZIONE	ADATTABILI A ORG
	A	B	d	sp.		
D	96	40	19	3	CASE CLAAS FARENDLOSE FAHR (NEW) FAHR FELLA FELLA IHC IHC (JI CASE) KRONE NIEMEYER PÖTTINGER PÖTTINGER PZ MT WELGER	113 3941 R1 978 241.4 00-011-054 0656 1542 1.1012.030.115.00 477 740 116 954 3101547 R1 1133936 R1 143698.0 570 404 434 991 700 06 165 0 452 S 09821506.00
D	98	40	19	3	BCS FAHR FARENDLOSE FORT GALFRE' MARANGON MORRA	580.29045.4 671 36/49 00.011.069 98D 98D 98D 98D
D	100	40	19	3	BCS FAHR	580 29045
D	108	40	19	3	MORRA	108/D
D	96	48	21	3	SIP	152 147 607
D	100	48	19	3		
D	100	48	21	3		
D	105	48	21	3	HAGEDORN SIP ZWEEGERS	1 4 7040 151019702 CM15
D	108	48	21	3	BELLON BELLON GALFRE' MORRA MARANGON NEW HOLLAND PZ	1803364 108D 108D 108D 108D 495 806 CM15 = 108D
D	108	48	19	3	GALFRE'	108D/19
D	96	40	19	4	CLAAS CLAAS JF FREUDENDAHL FELLA FELLA	949 240.0 949 240 .1 130-0025 477 762 116 956
D	108	40	19	4	GALFRE'	108D/19
D	102	45	16,5	4		
D	123	45	18,2	4	KUHN	564.512.10
D	105	48	19	4	FELLA	122.331
D	108	48	19	4	FORTSCHRITT	0310 4179 504



**COLTELLI PER FALCIATRICI ROTATIVE - ROTARY MOWER KNIVES**  
**ROTOR KLINGEN - COTEAUX DE FAUCHEUSES ROTATIVES**  
**CUCHILLAS PARA SEGADORAS ROTATIVAS - НОЖИ ДЛЯ РОТОРНОЙ КОСИЛКИ**

**PIEGATO NORMALE - NORMAL BENDED**  
**NORMAL GEBOGEN - PLIE' NORMALE - DOBLADA**  
**Изогнутый**

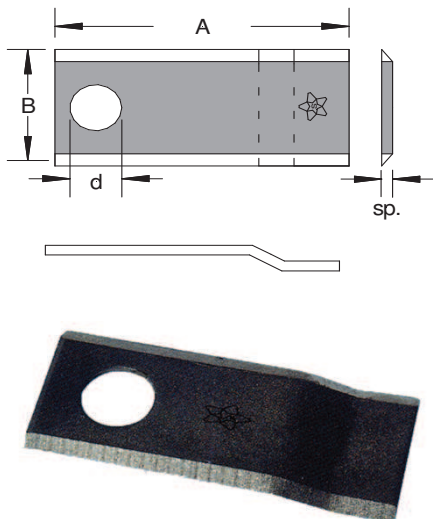

CODICE STELLA					APPLICAZIONE	ADATTABILI A ORG
	A	B	d	sp.		
PN	88	40	19	3	LINCE SUPERTINO	90P 88 P
PN	90	40	19	3	LINCE	90/P
PN	94	40	19	3	BELLON FAHR MORRA MARANGON	1-1017-010-153.22 94 P
PN	96	40	19	3	FAHR FAHR (NEW) FELLA FELLA IHC PÖTTINGER ZWEEGERS	1-1017-010-153.00 0656 1541 478 962 = 478.963 124 243 1133938R1 434993 TT97
PN	98	40	19	3	FAHRENDLOSE FELLA FORT FAHR GALFRE' MARANGON MORRA	00-11-07 124243 98P 98P 98P 98P
PN	108	40	19	3		
PN	105	48	21	3		
PN	108	48	19	3	GALFRE' BELLON GALFRE' NEW HOLLAND	108P 1803365 108P 495 807
			21			

**PIEGATO FORTE - STRONG BENDED**  
**STARK GEBOGEN - FORT PLIE' - DOBLADA FUERTE**  
**Сильно изогнутый**

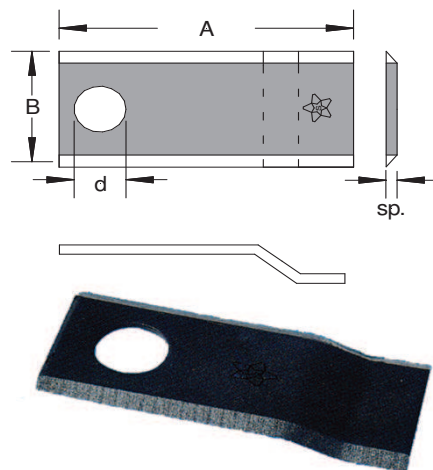

CODICE STELLA					APPLICAZIONE	ADATTABILI A ORG
	A	B	d	sp.		
PF	96	40	19	3	SUPERTINO P.F.	
PF	98	40	19	3		
PF	108	50	17	4	MAXAM	



**COLTELLI PER FALCIATRICI ROTATIVE - ROTARY MOWER KNIVES**  
**ROTOR KLINGEN - COTEAUX DE FAUCHEUSES ROTATIVES**  
**CUCHILLAS PARA SEGADORAS ROTATIVAS - НОЖИ ДЛЯ РОТОРНОЙ КОСИЛКИ**

**ELICOIDALE - HELICOIDAL**  
**SCHRAUBENFORMIG - HELICOIDAL - Винтовой**

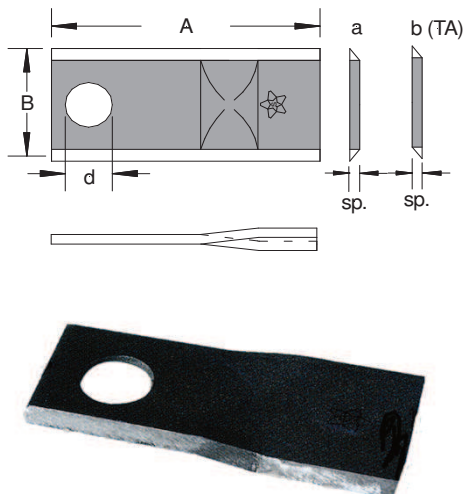

CODICE STELLA						APPLICAZIONE	ADATTABILI A ORG	LATO
EL	A	B	d	sp.				
EL	88	40	16,25	3	a	KUHN	561.510.00	SX
						KUHN	561.511.00	DX
EL	90	40	19	3	b	WELGER	0982.15.08.00	SX
						WELGER	0982.15.09.00	DX
EL	93	40	16,25	3	a	CASE	113 3939	SX
						CASE	113 3940	DX
						GASPARDO	513	SX
						GASPARDO	512	DX
						IHC (JI CASE)	1133939R1	SX
						IHC (JI CASE)	1133940R1	DX
						IHC (JI CASE)	3160419R1	SX
						IHC (JI CASE)	3160420R1	DX
						JOHN DEERE	CC 19 336	SX
						JOHN DEERE	CC 19 333	DX
						KUHN	561.512.00	SX
						KUHN	561.513.00	DX
						NEW HOLLAND	274 096	SX
						NEW HOLLAND	274 097	DX
EL	94	40	19	3	b	KRONE	147 419 5	SX
						KRONE	147 302 5	DX
						NEW HOLLAND	402 244	SX
						NEW HOLLAND	402 243	DX
EL	96	40	19	3	a	FAHR	1.1603.010.197.00	SX
						FAHR	1.1603.010.198.00	DX
						FAHR	0656 1547	SX
						FAHR	0656 1546	DX
						FAHR	1650 2727	SX
						FAHR	1650 2726	DX
						PÖTTINGER	434 996	SX
						PÖTTINGER	434 995	DX
EL	100	40	19	3	b	BCS	58029096	SX
						BCS	58029095	DX
						GRIBALDI & SALVIA	26013/S	SX
						GRIBALDI & SALVIA	26013/D	DX
EL	93	48	19	3	b	KRONE	151 386 0	SX
						KRONE	151 385 0	DX
						KRONE	145 869 1	SX
						KRONE	145 868 1	DX



**COLTELLI PER FALCIATRICI ROTATIVE - ROTARY MOWER KNIVES**  
**ROTOR KLINGEN - COTEAUX DE FAUCHEUSES ROTATIVES**  
**CUCHILLAS PARA SEGADORAS ROTATIVAS - НОЖИ ДЛЯ РОТОРНОЙ КОСИЛКИ**

**ELICOIDALE - HELICOIDAL**  
**SCHRAUBENFORMIG - HELICOIDAL - Винтовой**

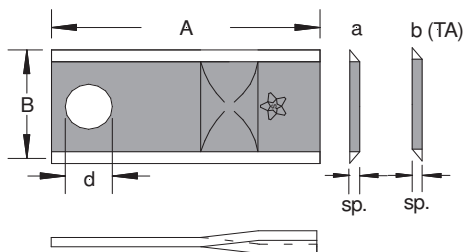

CODICE STELLA						APPLICAZIONE	ADATTABILI A ORG	LATO
	A	B	d	sp.				
EL	94	48	19	3	b	CLAAS	104.339.0	SX
						CLAAS	104.340.0	DX
						KRONE	151386.0	SX
						KRONE	151385.0	DX
						NIEMEYER	570 409	SX
						NIEMEYER	570 410	DX
					a	ZWEEGERS	TF 70	SX
						ZWEEGERS	TF 71	DX
						FELLA	121 692	SX
						FELLA	121 693	DX
EL	100	48	19	3	b	CLAAS	952 729.0	SX
						CLAAS	952 728.0	DX
						CLAAS	904.178.6	SX
						CLAAS	904.177.6	DX
						CLAAS	904.178.7	SX
						CLAAS	904.177.7	DX
						CLAAS	904.797.0	SX
						CLAAS	904.796.0	DX
						FORTSCRITT	0301 1680	SX
						FORTSCRITT	0301 1697	DX
						NIEMEYER	570 413	SX
						NIEMEYER	570 414	DX
						NIEMEYER	570 419	SX
						NIEMEYER	570 418	DX
PÖTTINGER	434983	SX						
PÖTTINGER	434984	DX						
EL	105	48	19	3	b	CLAAS	904 178.8	SX
						CLAAS	904 177.8	DX
						ZWEEGERS	DN 382	SX
						ZWEEGERS	DN 383	DX
			21			CLAAS	104 266.0	SX
						CLAAS	104 267.0	DX
						KVERNELAND	CM 137	SX
						KVERNELAND	CM 138	DX
ZWEEGERS	CM 137	SX						
ZWEEGERS	CM 138	DX						
EL	108	48	19/21	3	a	GALFRE'	108 EL	SX
						GALFRE'	108 EL	DX
EL	110	48	21	3	a	CLAAS	105 878.0	SX
						CLAAS	105 873.0	DX
EL	110	48	21	3	b	COMER	0404 7016	SX
						COMER	0404 7015	DX
EL	108	40	19/21	4	b	GALFRE'		SX
						GALFRE'		DX
EL	94	48	19	4	b	BCS	58.031.193	SX
						BCS	58.031.192	DX
						KVERNELAND	TA 321	SX
						KVERNELAND	TA 322	DX
						PZ / ZWEEGERS	TA-321	SX
						PZ / ZWEEGERS	TA-322	DX



**COLTELLI PER FALCIATRICI ROTATIVE - ROTARY MOWER KNIVES**  
**ROTOR KLINGEN - COTEAUX DE FAUCHEUSES ROTATIVES**  
**CUCHILLAS PARA SEGADORAS ROTATIVAS - НОЖИ ДЛЯ РОТОРНОЙ КОСИЛКИ**

**ELICOIDALE - HELICOIDAL**  
**SCHRAUBENFORMIG - HELICOIDAL - Винтовой**

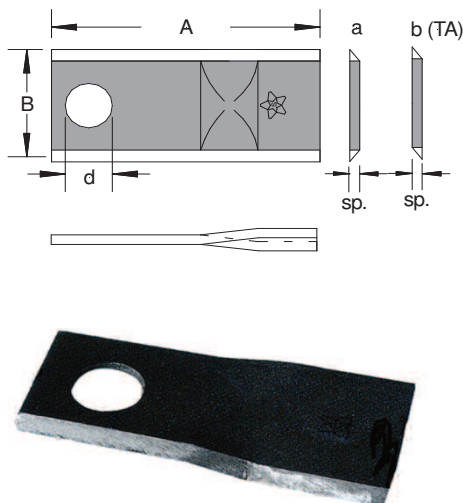

CODICE STELLA					APPLICAZIONE	ADATTABILI A ORG	LATO	
EL	A	B	d	sp.				
EL 96	96	48	19	4	b	FAHR	1650 3465	SX
						FAHR	1650 3464	DX
						FAHR	1650 3460	SX
						FAHR	1650 3658	DX
						KRONE	146 690 1	SX
						KRONE	146 691 1	DX
EL 98	98	48	19	4	b	BCS	58.036.091	SX
						BCS	58.036.090	DX
						FELLA	121 712	SX
						FELLA	121 713	DX
						GRIBALDI & SALVIA	121713/SP	SX
						GRIBALDI & SALVIA	121712/SP	DX
						PÖTTINGER	434 981	SX
						PÖTTINGER	434 982	DX
EL 100	100	48	19	4	b	GRIBALDI & SALVIA	46292	SX
						GRIBALDI & SALVIA	46291	DX
						FORTSCHRITT	0300 3350	SX
			FORTSCHRITT			0300 3367	DX	
			PÖTTINGER			434 973	SX	
			PÖTTINGER			434 974	DX	
			PÖTTINGER			434 977	SX	
PÖTTINGER	434 978	DX						
		21			MARANGON	980 204.171	SX	
					MARANGON	980 204.170	DX	
					MARANGON	MEL 100	SX	
					MARANGON	MER 100	DX	
EL 102	102	48	19	4	b	FELLA	140 693	SX
						FELLA	140 692	DX
EL 105	105	48	21	4	b	MARANGON	105	SX
						MARANGON	105	DX
					a	SITREX	110.119	SX
SITREX	110.118	DX						
EL 105	105	48	20,5x23	4	b	VICON	KT5514100001	SX
						VICON	KT5514200001	DX
EL 106	106	48	19	4	b	SIP	153 967 201	SX
						SIP	153 967 103	DX
						SIP	950 008 609	SX
						SIP	950 008 707	DX
						SIP	950 009 001	SX
						SIP	950 009 109	DX
						NIEMEYER	570 445	SX
						NIEMEYER	570 444	DX
						FELLA	122 329	SX
FELLA	122 330	DX						



**COLTELLI PER FALCIATRICI ROTATIVE - ROTARY MOWER KNIVES**  
**ROTOR KLINGEN - COTEAUX DE FAUCHEUSES ROTATIVES**  
**CUCHILLAS PARA SEGADORAS ROTATIVAS - НОЖИ ДЛЯ РОТОРНОЙ КОСИЛКИ**

**ELICOIDALE - HELICOIDAL**  
**SCHRAUBENFORMIG - HELICOIDAL - Винтовой**

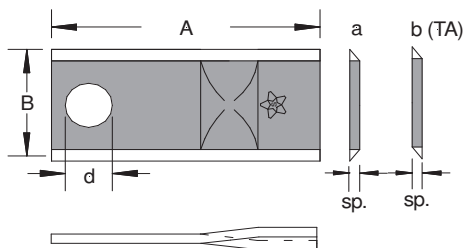

CODICE STELLA					APPLICAZIONE	ADATTABILI A ORG	LATO	
	A	B	d	sp.				
EL	107	48	18,5	4	b	KVERNELAND	B 087 5002	SX
						KVERNELAND	B 087 5001	DX
						HESSTON	700.711.858	SX
						HESSTON	700.711.857	DX
						HESSTON	700.715.576	SX
			HESSTON			700.715.575	DX	
			VICON			902 61559	SX	
			VICON			902 61560	DX	
			COMER			04047015/4	LH	
			COMER			04047016/4	RH	
EL	108	48	19	4	b	GALFRE'	434 985	SX
						GALFRE'	434 986	DX
						PÖTTINGER	434 985	SX
						PÖTTINGER	434 986	DX
						FORTSCRITT	0301 5161	SX
						FORTSCRITT	0301 5145	DX
			NIEMEYER			570 679 - 570 683	SX	
			NIEMEYER			570 680 - 570 684	DX	
			GRIBALDI & SALVIA			46362	SX	
			GRIBALDI & SALVIA			46363	DX	
			PÖTTINGER			434 971	SX	
			PÖTTINGER			434 972	DX	
GALFRE'		SX						
GALFRE'		DX						
SITREX	100.366	SX						
SITREX	100.367	DX						
EL	110	48	21	4	b	MARANGON	110 MEL	SX
						MARANGON	110 MER	DX
						COMER		SX
			COMER				DX	
			SIP			745032010	SX	
			SIP			745032020	DX	
EL	112	48	19	4	b	KRONE	139 888 0	SX
						KRONE	139 889 0	DX
						FELLA	123 706	SX
						FELLA	123 707	DX
						FELLA	131 117	SX
						FELLA	131 118	DX
						FELLA	134 309	SX
						FELLA	134 308	DX
						STOLL	1122350	SX
			STOLL			1122360	DX	
			J.F.			1380-0015	SX	
			J.F.			1380-0014	DX	
			PÖTTINGER			434 969	SX	
PÖTTINGER	434 970	DX						
EL	115	48	19	4	b	CLAAS	952.043.0	SX
						CLAAS	952.042.0	DX



**COLTELLI PER FALCIATRICI ROTATIVE - ROTARY MOWER KNIVES**  
**ROTOR KLINGEN - COTEAUX DE FAUCHEUSES ROTATIVES**  
**CUCHILLAS PARA SEGADORAS ROTATIVAS - НОЖИ ДЛЯ РОТОРНОЙ КОСИЛКИ**

**ELICOIDALE - HELICOIDAL**  
**SCHRAUBENFORMIG - HELICOIDAL - Винтовой**

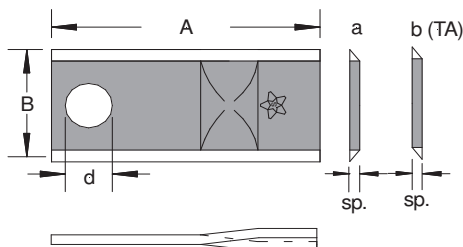

CODICE STELLA					APPLICAZIONE	ADATTABILI A ORG	LATO	
	A	B	d	sp.				
EL	120	48	18,5	4	b	FELLA	111 724	SX
						FELLA	111 725	DX
						FELLA	478 640	SX
						FELLA	478 641	DX
						JOHN DEERE	CC 21780	SX
						JOHN DEERE	CC 21781	DX
						KVERNELAND	B 191 9802	SX
						KVERNELAND	B 191 9902	DX
						LELY	4.1201.1473.0	SX
						LELY	4.1201.1474.0	DX
						LELY	9.1127.0003.2	SX
						LELY	9.1127.0004.3	DX
						NEW IDEA	526 216	SX
						NEW IDEA	526 215	DX
						NEW HOLLAND	444 266	SX
						NEW HOLLAND	444 267	DX
NEW HOLLAND	784 220	SX						
NEW HOLLAND	784 221	DX						
PÖTTINGER	434 988	SX						
PÖTTINGER	434 989	DX						
VICON	58 699 = 90258699	SX						
VICON	58 700 = 90258700	DX						
EL	95	45	16,25	3,5	a	JOHN DEERE	CC 20 500 = 19336	SX
						JOHN DEERE	CC 20 501 = 19333	DX
						KUHN	561.512.10	SX
						KUHN	561.513.10	DX
NEW HOLLAND	766 726	SX						
NEW HOLLAND	766 727	DX						
EL	98	45	16,25	3,5	a	FORT	4049 0006	SX
						FORT	4049 0005	DX
						MORRA		SX
						MORRA		DX
EL	107	45	21	4	a	BELLON	183 2532	SX
						BELLON	183 2533	DX
						BELLON	559 032 010 /21	SX
						BELLON	559 033 010 /21	DX
						ENOROSSI	12881270	SX
ENOROSSI	12881271	DX						
EL	107	45	18,25	4	a	FORT	40490006	SX
						FORT	49490005	DX
						JOHN DEERE	CC 26 780	SX
						JOHN DEERE	CC 26 781	DX
						KUHN	559.032.10	SX
						KUHN	559.033.10	DX
NEW HOLLAND	853 819	SX						
NEW HOLLAND	853 820	DX						
EL	112	45	21	4	b	ENOROSSI	12881434 / 18034173	SX
						ENOROSSI	12881435 / 18034193	DX



**COLTELLI PER FALCIATRICI ROTATIVE - ROTARY MOWER KNIVES**  
**ROTOR KLINGEN - COTEAUX DE FAUCHEUSES ROTATIVES**  
**CUCHILLAS PARA SEGADORAS ROTATIVAS - НОЖИ ДЛЯ РОТОРНОЙ КОСИЛКИ**

**ELICOIDALE - HELICOIDAL**  
**SCHRAUBENFORMIG - HELICOIDAL - Винтовой**

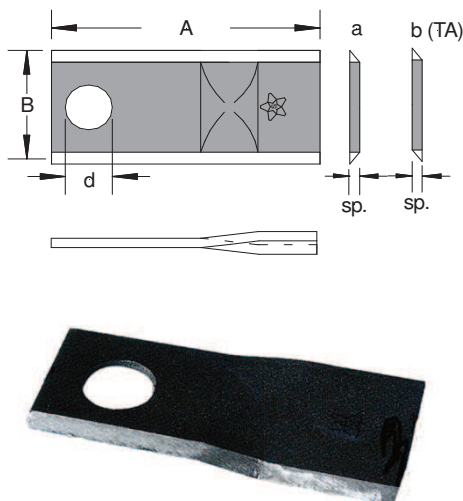

CODICE STELLA						APPLICAZIONE	ADATTABILI A ORG	LATO
	A	B	d	sp.				
EL	116	45	18,25	4	a	JOHN DEERE	CC 23 488	SX
						JOHN DEERE	CC 23 499	DX
						KUHN	559.060.00	SX
						KUHN	559.061.00	DX
						NEW HOLLAND	785 608	SX
						NEW HOLLAND	785 609	DX
EL	123	45	18,25	4	a	CLAAS	104 555.0	SX
						CLAAS	104 556.0	DX
						JOHN DEERE	CC 21 780	SX
						JOHN DEERE	CC 21 781	DX
						KUHN	564.512.00	SX
						KUHN	564.513.00	DX
						NEW HOLLAND	784 220	SX
						NEW HOLLAND	784 221	DX
EL	126	48	20,5x23	4	b	KVERNELAND	56110900	SX
						KVERNELAND	56110400	DX
						KVERNELAND	56781000	SX
						KVERNELAND	59782000	DX
						KUHN	56110900	SX
						KUHN	56110400	DX
						KUBOTA	KT5611090001	SX
						KUBOTA	KT5611040001	DX
EL	128	48	21	4	b	CNH	1380-0011	SX
						CNH	1380-0010	DX
EL	129	48	21	4	b	MARANGON	980 204.183	SX
						MARANGON	980 204.184	DX
						MARANGON	MEL 129	SX
						MARANGON	MER 129	DX
EL	105	49	21	4	b	SAMASZ	025.05.57.00	SX
						SAMASZ	025.05.58.00	DX
EL	109	50	21	4	b	MC HALE	CKN 00043	SX
						MC HALE	CKN 00042	DX
EL	110	50	22,75	4	b	NEW HOLLAND	9847683	SX
						NEW HOLLAND	9847684	DX
EL	120	50	22,75	4	b	NEW IDEA / BUSH HOG	527749	SX
						NEW IDEA / BUSH HOG	527748	DX
EL	176	50	20,5	4	b	BCS	56419369	SX
						BCS	56419783	DX
EL	94	49	23	3	b	MÖRTL	T/673L	SX
						MÖRTL	T/673R	DX





**COLTELLI PER FALCIATRICI ROTATIVE - ROTARY MOWER KNIVES**  
**ROTOR KLINGEN - COTEAUX DE FAUCHEUSES ROTATIVES**  
**CUCHILLAS PARA SEGADORAS ROTATIVAS - НОЖИ ДЛЯ РОТОРНОЙ КОСИЛКИ**

**PIEGATO PZ - BENDED PZ**

**GEBOGEN PZ - PLIE' PZ - DOBLADA PZ - Изогнутый PZ**

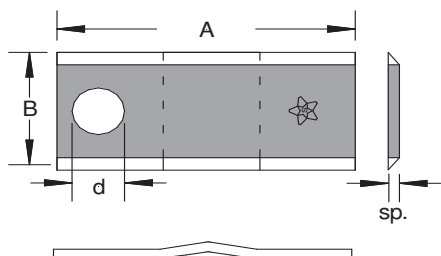

CODICE STELLA					APPLICAZIONE	ADATTABILI A ORG
	A	B	d	sp.		
PZ	105	48	21	3	BELLON PZ CM PÖTTINGER CLAAS KRONE RZS RZS ZWEEGERS KUHN GREENLAND	105 PZ 120.105 434 120 104 004.1 143 237 0 165 419500310 CM 120 Z1100020 CM 120
PZ	108	48	21	3	BELLON MARANGON NEW HOLLAND ZWEEGERS PZ	108 PZ CM120-108 495.807 CM 120/108
PZ	108	48	21	4	MARANGON	



**COLTELLI PER FALCIATRICI ROTATIVE - ROTARY MOWER KNIVES**  
**ROTOR KLINGEN - COTEAUX DE FAUCHEUSES ROTATIVES**  
**CUCHILLAS PARA SEGADORAS ROTATIVAS - НОЖИ ДЛЯ РОТОРНОЙ КОСИЛКИ**



# VITI, DADI e BULLONI

[www.stellalame.com](http://www.stellalame.com)



**VITI, DADI & BULLONI - BLADE BOLT & NUT**  
**KLINGEBOLZEN & SICHERUNGSMUTTER - BOULONS & ÉCROU**  
**TORNILLOS & TUERCA - ВИНТЫ, ГАЙКИ И БОЛТЫ**

Codice

Adattabili a: Codice

Adattabili a:

**Viti per sezioni e denti mietitrebbia**

**M6 x 16**



Laverda 322707450+360653406  
 SCH 420100012+001106001  
 SCH 10931 + 13961  
 John Deere

**M10 x 35**



**NEW**

SCH 13014 + 13955  
 011106621 + 011701711  
 Varie

**M12 x 45**



**NEW**

**Bulloni per falciatrici rotanti**

**BM1215**

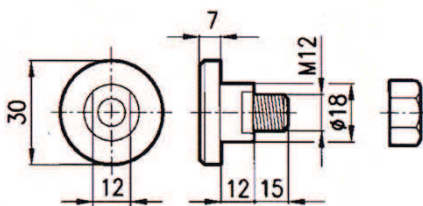

Kuhn 56115800  
 J.Deere CC19994  
 New Holland 687552

**BM1013**

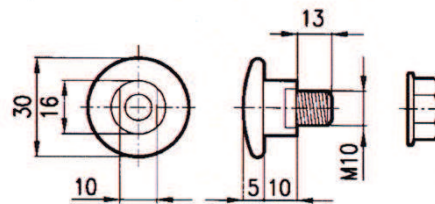

Kuhn 56210100  
 J.Deere CC19989  
 New Holland 274092-766728

**BM1016**

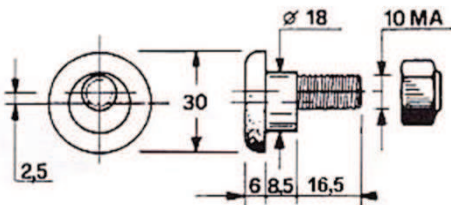

Vicon 81160  
 New Holland  
 John Deere

**BM1218**

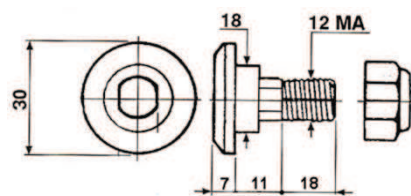

Vicon B1374593

**Bulloni per coltelli carri miscelatori**

**M12 x 40 con nasello**



**NEW**

Storti 161213334 (Vite)  
 Storti 90800513 (Bullone)  
 Storti 90809007 (Bullone autobloc.)

**M10 x 35 Q**

**M12 x 40 Q**

**M16 x 55 Q**



Storti  
 Varie



# TRINCIAPAGLIA & BOCCOLE

[www.stellalame.com](http://www.stellalame.com)



**TRINCIAPAGLIA - STRAW CHOPPER KNIVES**  
**STROHNACKSLERMESSER - COUTEAUX BROYEUR DE PAILLE**  
**CUCHILLAS CORTAPAJAS - НОЖИ СОЛОМОИЗМЕЛЬЧИТЕЛЯ**

Codice	Adattabili a:	TRATT. TERMICO	HEAT TREATMENT	
<b>TPML 50-3-18</b>				
	Biso	28259044	Totale	Total
	Biso	28.801.405-0014	Totale	Total
	Biso	28.801.405-0032/33	Totale	Total
	Claas	060.017.2	Foro + tagliente	Hole + cutting
	J. Deere	Z.35.221	Tagliente	Cutting
	M. Ferguson	1730 728 M2	Totale	Total
	New Holland	746 812	Totale	Total
	New Holland	80 746812	Foro + tagliente	Hole + cutting
	Laverda	321723250	Foro + tagliente	Hole + cutting
	Laverda	320706150	Totale	Total
	Deutz Fahr	0654-5847	Foro + tagliente	Hole + cutting
	Lova	28-14	Totale	Total

<b>TPML 50-4-18</b>				
	Dronningborg	490 18900		
	Biso	28272068	Foro + tagliente	Hole + cutting
	Biso	28.345-115		
	Biso	28.801.405-0034		
	Biso	28.272.028 / 28.274.048		
	Claas	821075.0 = 060.017.2-4		
	J. Deere	Z.48.237 / Z.53.454	Foro + tagliente	Hole + cutting
	New Holland	80 746813	Foro + tagliente	Hole + cutting
	New Holland	80 743557	Foro + tagliente	Hole + cutting
	Lova	28.14-4	Totale	Total
	Dronningborg	490 17800		
Deutz Fahr	0654 6847			

<b>TPMS 50-3-18</b>				
	Biso	28.274-024	Foro + tagliente	Hole + cutting
	Claas	065.294.0		

<b>TPMS 50-4-18</b>				
	Biso	28.274.025 / 28.274.036	Foro + tagliente	Hole + cutting
	Biso	28-345-117		
	Biso	28.274-051		
	Biso	28-14-4 Z		
	New Holland	9510635	Foro + tagliente	Hole + cutting
	New Holland	89815911 / 84065059		
	CNH	86517963		
	CNH	84441392	(piegato)	
	J. Deere	Z77601		
Deutz Fahr	1600 0617			



**TRINCIAPAGLIA - STRAW CHOPPER KNIVES**  
**STROHHACKSLERMESSER - COUTEAUX BROYEUR DE PAILLE**  
**CUCHILLAS CORTARAJAS - НОЖИ СОЛОМОИЗМЕЛЬЧИТЕЛЯ**

Codice Adattabili a: TRATT. TERMICO HEAT TREATMENT

**TPML 50-5-18**

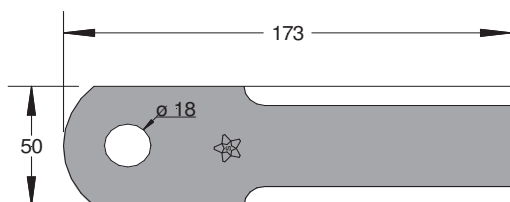

J. Deere

Z.42.176

Tagliente

Cutting

**TPMS 50-5-18**

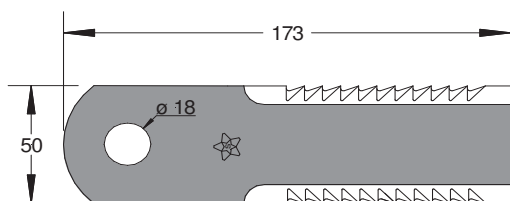

New Holland

84437624

Totale  
Foro + tagliente

Total  
Hole + cutting

**TPMS TTL 50-4-18**

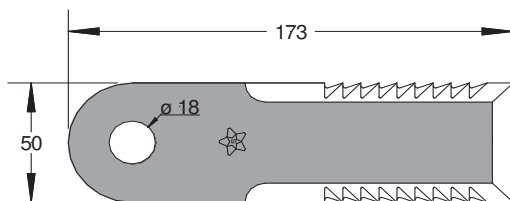

Laverda  
New Holland

322326450

Foro + tagliente

Hole + cutting

**TPMS TTS 50-4-18**

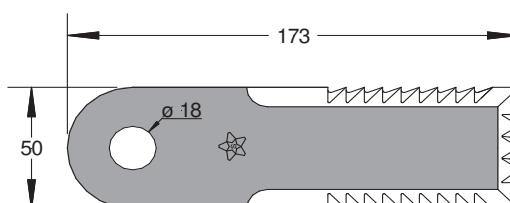

J. Deere  
Biso-Titanio  
Biso  
Biso  
Claas  
Laverda  
New Holland  
New Holland  
Deutz Fahr

Z.55.610  
28274490000  
282740410000  
18173504  
322235450  
89833966  
84037550  
160018725

Foro + tagliente  
Foro + tagliente  
Foro + tagliente  
Foro + tagliente  
Foro + tagliente  
Foro + tagliente  
Foro + tagliente

Hole + cutting  
Hole + cutting  
Hole + cutting  
Hole + cutting  
Hole + cutting  
Hole + cutting  
Hole + cutting

**TPML 50-3,5-20**

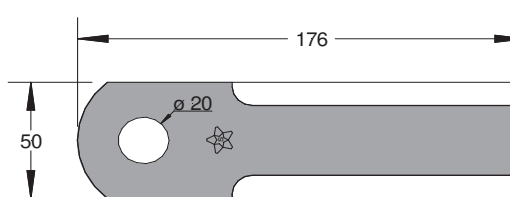

Rekord

41 348  
40741348

Foro + tagliente

Hole + cutting



**TRINCIAPAGLIA - STRAW CHOPPER KNIVES**  
**STROHNACKSLERMESSER - COUTEAUX BROYEUR DE PAILLE**  
**CUCHILLAS CORTARAJAS - НОЖИ СОЛОМОИЗМЕЛЬЧИТЕЛЯ**

Codice Adattabili a: TRATT. TERMICO HEAT TREATMENT

**TPML 50-4,5-20**

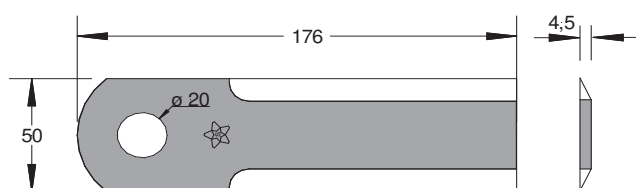

Rekord	44 280
Laverda	320999350
New Holland	840196200

Foro + tagliente	Hole + cutting
Totale	Total

**TPMS 50-4,5-20**

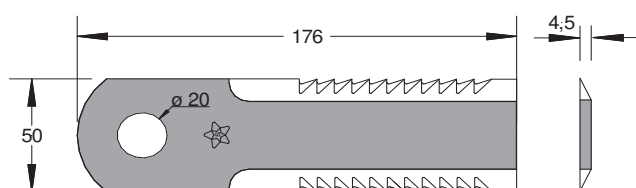

Rekord	
New Holland	84068444
J. Deere	Z 75875
M. Ferguson	49074600

Foro + tagliente	Hole + cutting
Totale	Total

**TPML 50-3-21**

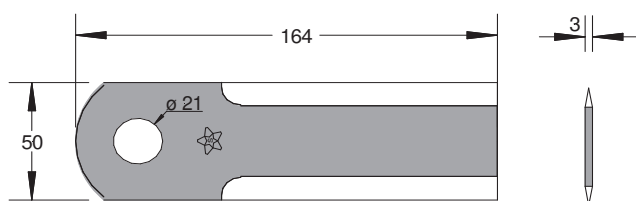

Lova	2209.0015-S1
------	--------------

Totale	Total
--------	-------

**TPML 50-3-18 L177**

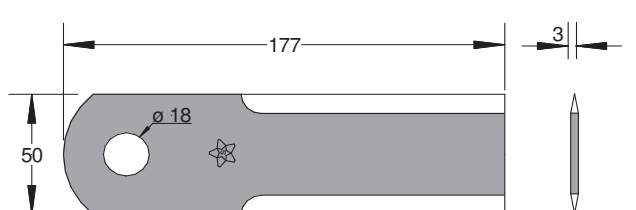

Laverda	2109
---------	------

Totale	Total
--------	-------

**TPML 50-3-12**

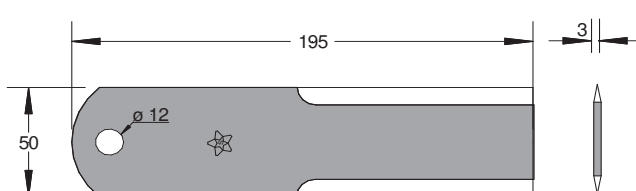

Claas	060.030.2
Claas	060.030.0
J. Deere	Z.35.241
Lova	2309.0045-S1
Biso	41.001-121
Dronningborg	490 19000
Laverda	320706250 - 321722850

Tagliente	Cutting
Tagliente	Cutting
Totale	Total
Tagliente	Cutting





**TRINCIAPAGLIA - STRAW CHOPPER KNIVES**  
**STROHHACKSLERMESSER - COUTEAUX BROYEUR DE PAILLE**  
**CUCHILLAS CORTARAJAS - НОЖИ СОЛОМОИЗМЕЛЬЧИТЕЛЯ**

Codice	Adattabili a:	TRATT. TERMICO	HEAT TREATMENT	
<b>TPMS 50-3-12</b>				
	Claas	060 030.2 Z	Totale	Total
	Claas	0600302Z	Totale	Total
	Claas	737.600.0	Totale	Total

Codice	Adattabili a:	TRATT. TERMICO	HEAT TREATMENT	
<b>CONTROCOLTELLO LISCIO</b>				
	Biso	28.801.402- 0017	Totale	Total
	Biso	2809/3	Totale	Total
	New Holland	80 746 805	Totale	Total
	Deutz Fahr	0620-4848	Totale	Total
	J. Deere	Z.59.020	Totale	Total
	J. Deere	HXE13023	Totale	Total
	Dronningborg	490 18300	Totale	Total

Codice	Adattabili a:	TRATT. TERMICO	HEAT TREATMENT	
<b>CONTROCOLTELLO DENTATO</b>				
	Deutz Fahr	1600-0616	Totale	Total
	Biso	28.274-024	Totale	Total
	Biso	28.09/3 Z	Totale	Total
	J. Deere	Z.59.033	Totale	Total
	J. Deere	HXE13024	Totale	Total
	Laverda	322291650	Totale	Total
	Laverda	322235550	Totale	Total
	New Holland	89516450	Totale	Total

Codice	Adattabili a:	TRATT. TERMICO	HEAT TREATMENT	
<b>CCL 40-3-10,4</b>				
	Rekord	40151	Totale	Total
	Laverda	320997650		
	CNH	1322233C2		
	J. Deere	Z75874		
	Dronningborg	D49005700		

Codice	Adattabili a:	TRATT. TERMICO	HEAT TREATMENT	
<b>CCS 40-3-10,4</b>				
	Rekord	40151 Serrated	Totale	Total



**TRINCIAPAGLIA - STRAW CHOPPER KNIVES**  
**STROHHACKSLERMESSER - COUTEAUX BROYEUR DE PAILLE**  
**CUCHILLAS CORTARAJAS - НОЖИ СОЛОМОИЗМЕЛЬЧИТЕЛЯ**

Codice	Adattabili a:	TRATT. TERMICO	HEAT TREATMENT	
<b>TPML 50-4-20</b>				
	Claas	736 872.0	Foro + tagliente	Hole + cutting
	Claas	7368720	Foro + tagliente	Hole + cutting
	Claas	05538602	Con riporto al Tungsteno	With Tungsten covering

<b>TPMS 50-4-20</b>				
	Claas	755.784.0	Foro + tagliente	Hole + cutting
	Claas	7557840	Foro + tagliente	Hole + cutting

<b>TPML TTL 50-4-20 + BOCCOLA</b>				
	Claas	755 787.1	Tagliente	Cutting
	Claas	7557871	Tagliente	Cutting

<b>TPML 50-4-20 + BOCCOLA</b>				
	Claas	755 874.0	Tagliente	Cutting
	Claas	7558740	Tagliente	Cutting

<b>TPMS TTL 50-4-20 + BOCCOLA</b>				
	Claas	755.875	Tagliente	Cutting
	Claas	755875	Tagliente	Cutting



**TRINCIAPAGLIA - STRAW CHOPPER KNIVES**  
**STROHNACKSLERMESSER - COUTEAUX BROYEUR DE PAILLE**  
**CUCHILLAS CORTAPAJAS - НОЖИ СОЛОМОИЗМЕЛЬЧИТЕЛЯ**

<b>Codice</b>	<b>Adattabili a:</b>	<b>TRATT. TERMICO</b>	<b>HEAT TREATMENT</b>
---------------	----------------------	-----------------------	-----------------------

**TPMS 50-5-20**

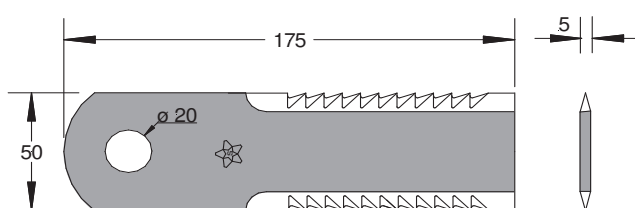

New Holland	87318316
J. Deere	Z105500

Totale	Total
--------	-------

**TPML 50-4,5-20 + BOCCOLA**

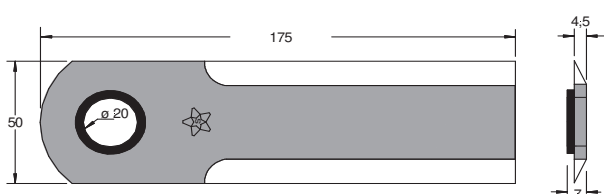

CNH	1994760 C4
Rekord	44443

Tagliente	Cutting
-----------	---------

**TPMS 50-4,5-20 + BOCCOLA**

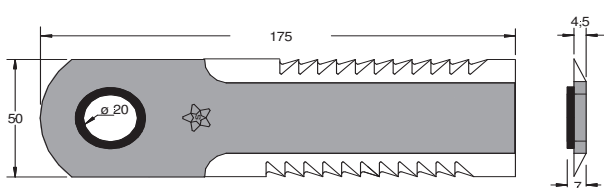

CNH	1994760 C4R
-----	-------------

Tagliente	Cutting
-----------	---------

**TPMLS 50-4,5-20 + BOCCOLA**

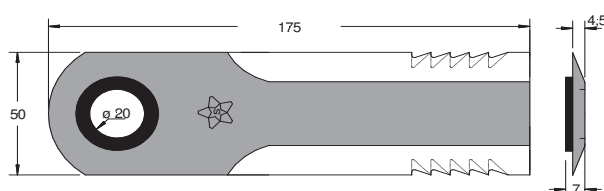

CNH	87593795
-----	----------

Tagliente	Cutting
-----------	---------

**TPML 50-3-12 L 140**

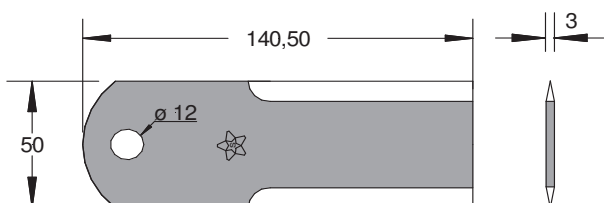

New Holland	87318524
New Holland	84437640

Totale	Total
--------	-------



**TRINCIAPAGLIA - STRAW CHOPPER KNIVES**  
**STROHNACKSLERMESSER - COUTEAUX BROYEUR DE PAILLE**  
**CUCHILLAS CORTAPAJAS - НОЖИ СОЛОМОИЗМЕЛЬЧИТЕЛЯ**

Codice

Adattabili a:

**TPMS 50-3-14,5**

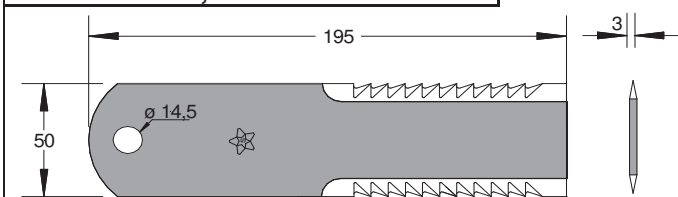

**ST 92550 DX / ST 92551 SX**

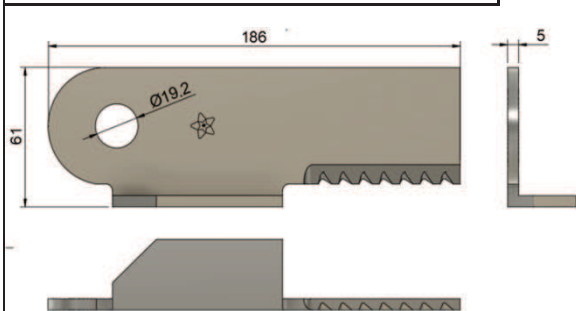

Versione DX

J. Deere	KXE 10363	Kit 4+4	<b>NEW</b>
J. Deere	KXE 10364	Kit 4+4	
J. Deere	KXE 10255	Kit 4+4	
J. Deere	AH 225937	Kit 4+4	
J. Deere	AH 213457	Kit 4+4	
J. Deere	AXE 92550	DX / RH	
J. Deere	AXE 92551	SX / LH	
J. Deere	H 218170	DX / RH	
J. Deere	H 218169	SX / LH	
J. Deere	H212700	DX / RH	(no hardface)
J. Deere	H212699	SX / LH	(no hardface)

**TRINCIPIEG. DX / SX 18**

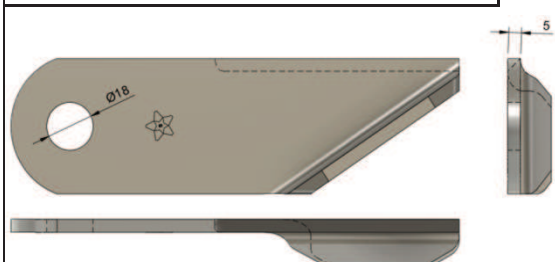

Versione SX

New Holland	87031978	DX / RH	<b>NEW</b>
New Holland	87031976	SX / LH	

**TRINCIPIEG. DX / SX 20**

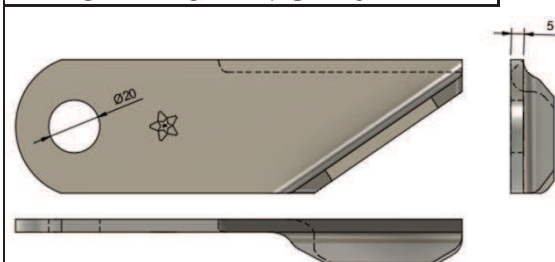

Versione SX

New Holland	87384920	DX / RH	<b>NEW</b>
New Holland	87384918	SX / LH	

**TRINCIPIEG. 195 f.19,2 DX/SX**

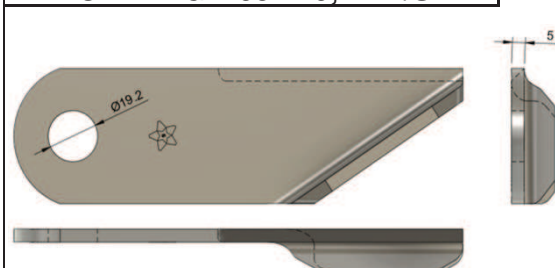

Versione SX

J. Deere	AH 205909	Kit 4+4	<b>NEW</b>
J. Deere	H 203894	DX / RH	
J. Deere	H 203895	SX / LH	



**BOCCOLE - BUSHING**  
**BUCHSEN - BAGUES - BUJE - ВТУЛКИ**

Codice

Adattabili a:

Codice

Adattabili a:

**BCL 3**

Boccole per trinciapaglia sp.3 mm

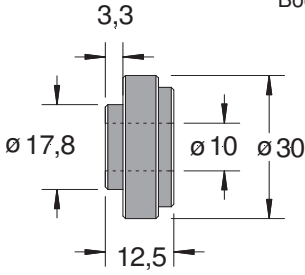

Deutz Fahr 06238559  
 Bisio 28.801.405.0012/3  
 J.Deere Z35216/3  
 Claas  
 New Holland 80746810

**BCL 4**

Boccole per trinciapaglia sp.4 mm

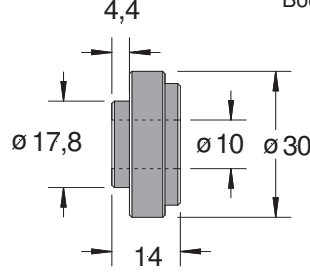

Deutz Fahr 06546848  
 Bisio 28.801.405.012/4  
 Bisio 28.203.068.000  
 J.Deere Z51243/4  
 Claas  
 New Holland 80746732

**BCLI 4,5**

Boccole interna per trinc. sp. 4,5 mm

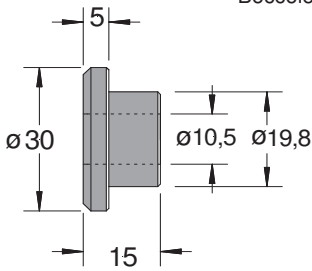

Cnh 1994758C2  
 Jhc

**BCLI 3**

Boccole interna per trinc. sp. 3 mm

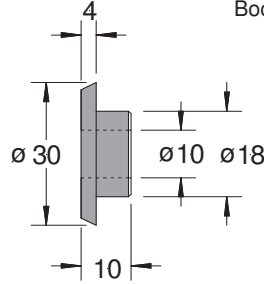

Claas 060.016.2

**BCLI 4**

Boccole interna per trinc. sp. 4 mm

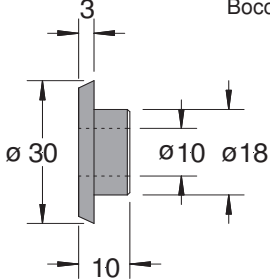

Claas 060.016

**BCLE 3-4**

Boccole esterna per trinc. sp. 3-4 mm

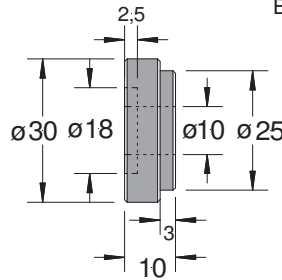

Claas 060.015

**DIST 4**

Distanziale

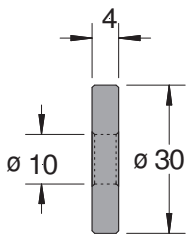

Deutz Fahr 06546849  
 Bisio 28.801.405.0013  
 Claas 736 870.1  
 J.Deere Z 66313  
 J.Deere Z 35217

**BCL 5 f.18**

Boccole per trinciapaglia sp.5 mm

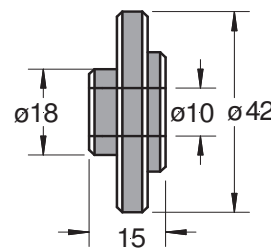

New Holland 84437622

**BCL 5 f.20**

Boccole per trinciapaglia sp.5 mm

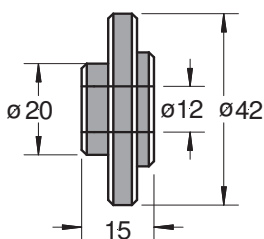

New Holland 87378123



**BOCCOLE - BUSHING**  
**BUCHSEN - BAGUES - BUJE - ВТУЛКИ**

Codice

Adattabili a:

Codice

Adattabili a:













# TRINCIASTOCCHI / TRINCIA MAIS COLTELLI TESTATA MAIS

[www.stellalame.com](http://www.stellalame.com)

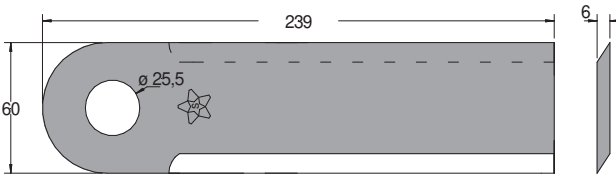
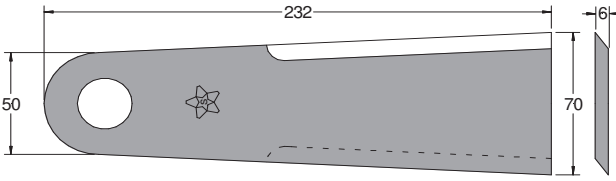
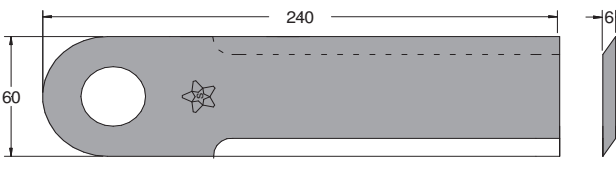
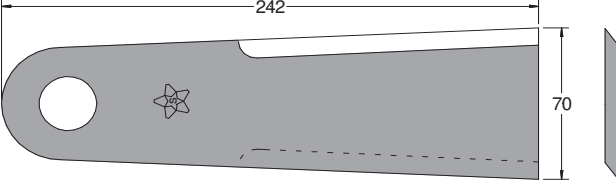
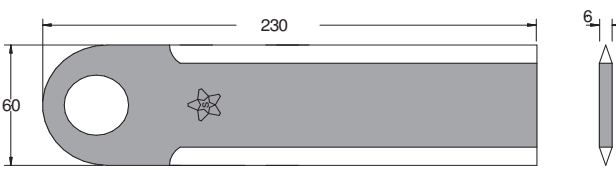

**TRINCIASTOCCHI / TRINCIA MAIS - KNIVES FOR MAIZE**  
**SCHELEGELMESSER FÜR MAIS - COUTEAUX POUR LE MAIS**  
**CUCHILLAS PARA MAIS - НОЖИ КУКУРУЗНОЙ ЖАТКИ**

Codice	Adattabili a:	TRATT. TERMICO	HEAT TREATMENT
<b>TRINCIA 239</b>	 <p>Capello mod. Diamante Totale Total</p>		
<b>TRINCIA 232</b>	 <p>Capello 03202103 Totale Total</p>		
<b>TRINCIA 240</b>	 <p>Capello 03202100 mod. Quasar Totale Total</p>		
<b>TRINCIA 242</b>	 <p>Capello</p>		
<b>TRINCIA 230</b>	 <p>Totale Total</p>		



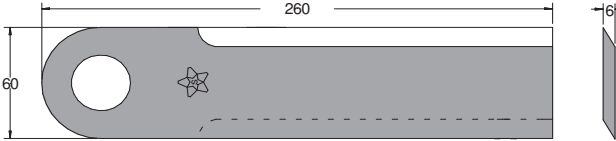
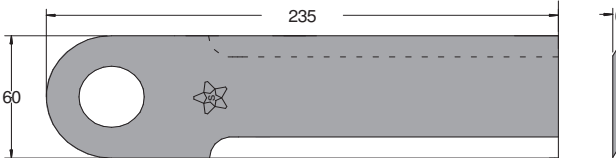
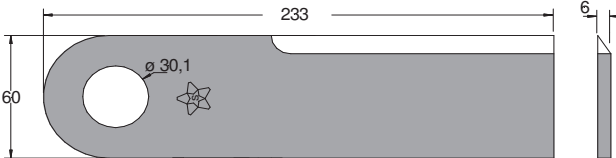
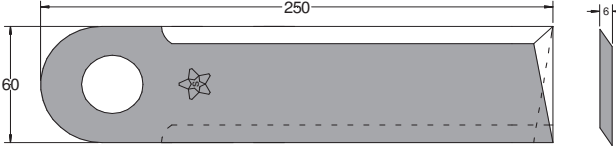

**TRINCIASTOCCHI / TRINCIA MAIS - KNIVES FOR MAIZE  
SCHELEGELMESSER FÜR MAIS - COUTEAUX POUR LE MAIS  
CUCHILLAS PARA MAIS - НОЖИ КУКУРУЗНОЙ ЖАТКИ**

Codice	Adattabili a:	TRATT. TERMICO	HEAT TREATMENT
<b>TRINCIA 293</b>			
	Fantini	13741	Totale Total
<b>TRINCIA 260</b>			
	Fantini	13739	Totale Total
<b>TRINCIA 235</b>			
	Fantini	21917	Totale Total
<b>TRINCIA 233</b>			
	Laverda New Holland	322593450	Totale Total
<b>TRINCIA 230 CASE</b>			
	Case / NH Case / NH New Holland	84976065 84976064 84340041	Totale Total Totale Total Totale Total



**TRINCIASTOCCHI / TRINCIA MAIS - KNIVES FOR MAIZE  
SCHELEGELMESSER FÜR MAIS - COUTEAUX POUR LE MAIS  
CUCHILLAS PARA MAIS - НОЖИ КУКУРУЗНОЙ ЖАТКИ**

**Codice** **Adattabili a:** **TRATT. TERMICO** **HEAT TREATMENT**

**TRINCIA 250 CLAAS**

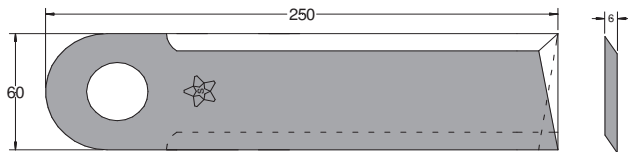

Claas	998683.0	Totale	Total
Claas	994233.0	Totale	Total

**TRINCIA 220**

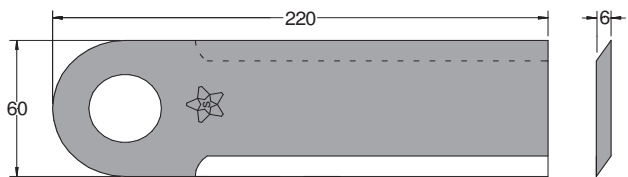

Oros	1310741	Totale	Total
Oros	1.310.741	Totale	Total

**ALTRI MODELLI**

Geringhoff	502692 - 502675
Geringhoff	502840 - 502841
Geringhoff	506035 - 506282
Fantini	13739
Oros	1319929
Oros	11-045258
Olimac	DR12300
DBF	271060030
Kemper	LCA 86215 - 8145



**TRINCIASTOCCHI / TRINCIA MAIS - KNIVES FOR MAIZE**  
**SCHELEGELMESSER FÜR MAIS - COUTEAUX POUR LE MAIS**  
**CUCHILLAS PARA MAIS - НОЖИ КУКУРУЗНОЙ ЖАТКИ**

Codice

Adattabili a:

TRATT.  
TERMICO

HEAT  
TREATMENT

**SCK 87106692**

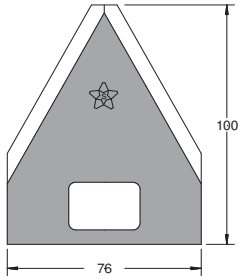

CNH

87106692

Totale

Total

**LTM 448-65-6**

Lama testata mais

New Holland

322426950

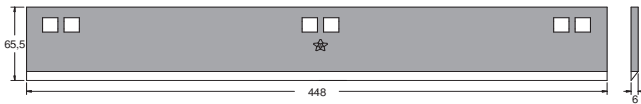

**LTM 488-66-6**

Lama testata mais

CNH

322591950

Laverda

322591950

New Holland

84433810

New Holland

86628054

New Holland

84976542

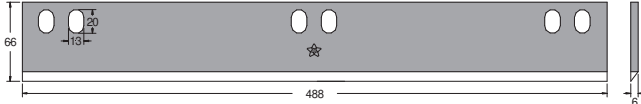

**LTM 543-54-6**

Lama testata mais

New Holland

80457477

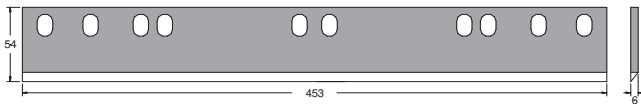

**LTM 457-56-6**

Lama testata mais

CNH

1327126C1

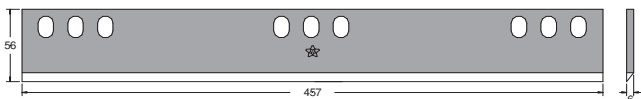

**TRINCIASTOCCHI / TRINCIA MAIS - KNIVES FOR MAIZE**  
**SCHELEGELMESSER FÜR MAIS - COUTEAUX POUR LE MAIS**  
**CUCHILLAS PARA MAIS - НОЖИ КУКУРУЗНОЙ ЖАТКИ**

Codice

Adattabili a:

TRATT.  
TERMICO

HEAT  
TREATMENT

<b>LTM 400-63-6</b>		
Lama testata mais	Capello	03.4100.00 - 03410000

<b>LTM 530-60-6</b>		
Lama testata mais	Fantini	12133

<b>ALTRI MODELLI</b>		
Lame testata mais	Geringhoff	502350 - 502356 (DX)
	Geringhoff	502351 - 502357 (SX)
	Capello	03.2019.00 (Mod. Quasar)
	Fantini	03950
	Fantini	4099
	Olimac	DR11030
	Oros	11-060584
	Oros	19-045060

--	--	--



# LAME KEMPER

[www.stellalame.com](http://www.stellalame.com)



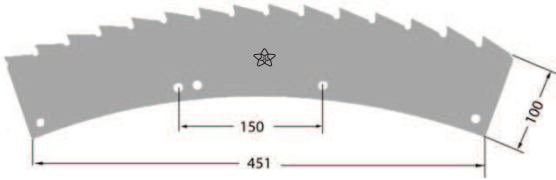
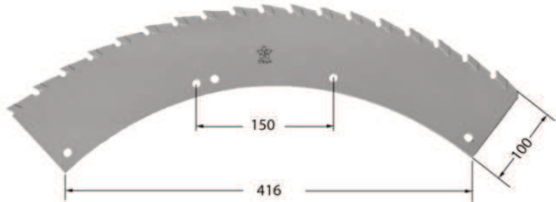
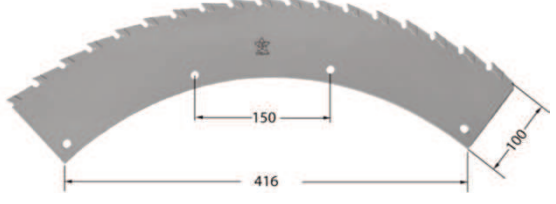
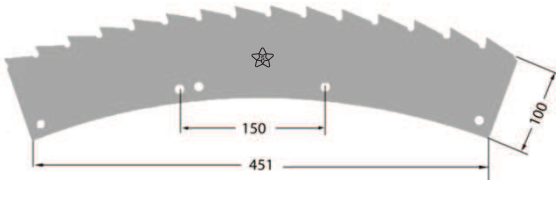

**LAME KEMPER - KEMPER KNIVES**  
**KEMPERHÄCKSELKLINGEN- LAME DE SCIE KEMPER**  
**CUCHILLAS PARA FORRAJE KEMPER**

Code	Adattabili a:	Spessore	Trattamento
<b>STK 53030</b>	Kemper 53030	2,5 mm	
 <p>The diagram shows a curved blade with a total length of 451 mm and a mounting hole spacing of 150 mm. The blade has a thickness of 100 mm at the tip. A star-shaped logo is visible on the blade's surface.</p>			
<b>STK 66035</b>	Kemper 66035	3,5 mm	
 <p>The diagram shows a curved blade with a total length of 416 mm and a mounting hole spacing of 150 mm. The blade has a thickness of 100 mm at the tip. A star-shaped logo is visible on the blade's surface.</p>			
<b>STK 66036</b>	Kemper 66036	2,5 mm	
 <p>The diagram shows a curved blade with a total length of 416 mm and a mounting hole spacing of 150 mm. The blade has a thickness of 100 mm at the tip. A star-shaped logo is visible on the blade's surface.</p>			
<b>STK 66037</b>	Kemper 66037	3,5 mm	
 <p>The diagram shows a curved blade with a total length of 451 mm and a mounting hole spacing of 150 mm. The blade has a thickness of 100 mm at the tip. A star-shaped logo is visible on the blade's surface.</p>			

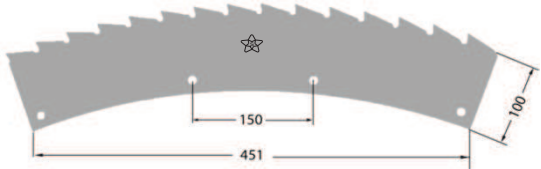
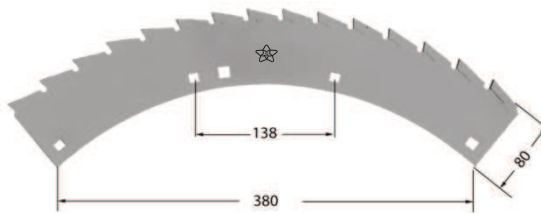
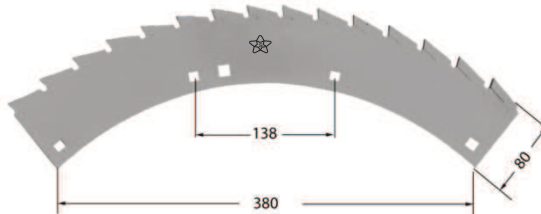

**LAME KEMPER - KEMPER KNIVES**  
**KEMPERHÄCKSELKLINGEN- LAME DE SCIE KEMPER**  
**CUCHILLAS PARA FORRAJE KEMPER**

Code	Adattabili a:	Spessore	Trattamento
<b>STK 66038</b>	Kemper 66038	2,5 mm	
			
<b>STK 67746</b>	Kemper 67746	2,5 mm	
			
<b>STK 78230 RH TN</b> <b>STK 78231 LH TN</b>	Kemper 78230 Right / Destra Kemper 78231 Left / Sinistra	2,5 mm 2,5 mm	Riporto al Tungsteno Riporto al Tungsteno
			
<b>STK 78232 RH TN</b> <b>STK 78233 LH TN</b>	Kemper 78232 Right / Destra Kemper 78233 Left / Sinistra	3,5 mm 3,5 mm	Riporto al Tungsteno Riporto al Tungsteno
 <p style="text-align: center;">immagine non disponibile</p>			



**LAME KEMPER - KEMPER KNIVES**  
**KEMPERHÄCKSELKLINGEN- LAME DE SCIE KEMPER**  
**CUCHILLAS PARA FORRAJE KEMPER**

Code	Adattabili a:	Spessore	Trattamento	
STK 78234 RH TN STK 78235 LH TN				
 immagine non disponibile	Kemper 78234	Right / Destra	2,5 mm	Riporto al Tungsteno
	Kemper 78235	Left / Sinistra	2,5 mm	Riporto al Tungsteno

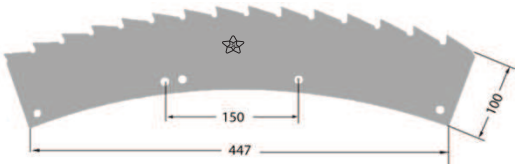
STK 78236 LH TN STK 78237 RH TN				
	Kemper 78236	Left / Sinistra	3,5 mm	Riporto al Tungsteno
	Kemper 78237	Right / Destra	3,5 mm	Riporto al Tungsteno

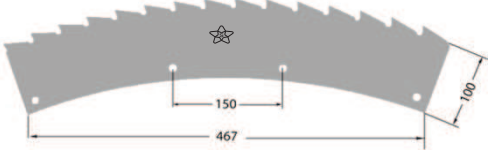
STK 78238 LH TN STK 78239 RH TN				
	Kemper 78238	Left / Sinistra	2,5 mm	Riporto al Tungsteno
	Kemper 78239	Right / Destra	2,5 mm	Riporto al Tungsteno

--	--	--	--	--





**LAME KEMPER - KEMPER KNIVES**  
**KEMPERHÄCKSELKLINGEN- LAME DE SCIE KEMPER**  
**CUCHILLAS PARA FORRAJE KEMPER**

**Code** **Adattabili a:** **Spessore** **Trattamento**

--	--	--	--

--	--	--	--

--	--	--	--

--	--	--	--



**LAME KEMPER - KEMPER KNIVES**  
**KEMPERHÄCKSELKLINGEN- LAME DE SCIE KEMPER**  
**CUCHILLAS PARA FORRAJE KEMPER**

**Code** **Adattabili a:** **Spessore** **Trattamento**

--	--	--	--

--	--	--	--

--	--	--	--

--	--	--	--



# COLTELLI PER CANNA DA ZUCCHERO

[www.stellalame.com](http://www.stellalame.com)



**COLTELLI PER CANNA DA ZUCCHERO**  
**CHOPPER KNIVES SUGAR CANE - COUTEAUX POUR LA CANNE À SUCRE**  
**MESSER FÜR ZUCKERROHR**  
**CUCHILLAS DE CAÑA DE AZUCAR - LÂMINAS DE CANA DE AÇÚCAR**  
**НОЖИ МАШИНЫ ДЛЯ УБОРКИ САХАРНОГО ТРОСТНИКА**

Codice:

Adattabili a:

TRATT.  
TERMICO

HEAT  
TREATMENT

**BCB 267-90-5**

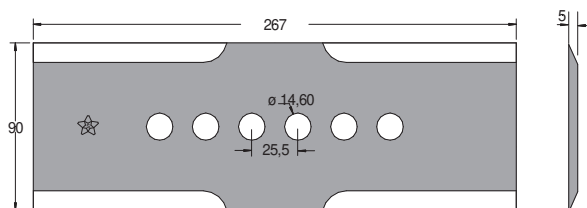

Case 448928A1

Specifico

Specific

Altri modelli su richiesta

Coltello per canna da zucchero / Base cutter blades / Chopper knife sugar cane harvester / Chucillas de caña de azucar

**CB 845-8**

Case 47430491 (sost.87214899)

Specifico

Specific

Case 87214899 (h.65)

Specifico

Specific

J. Deere 243005174 (h.95)

Specifico

Specific

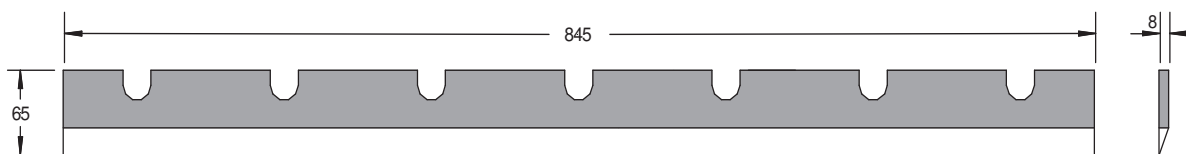

# LAME PER CARRI DESILATORI

[www.stellalame.com](http://www.stellalame.com)

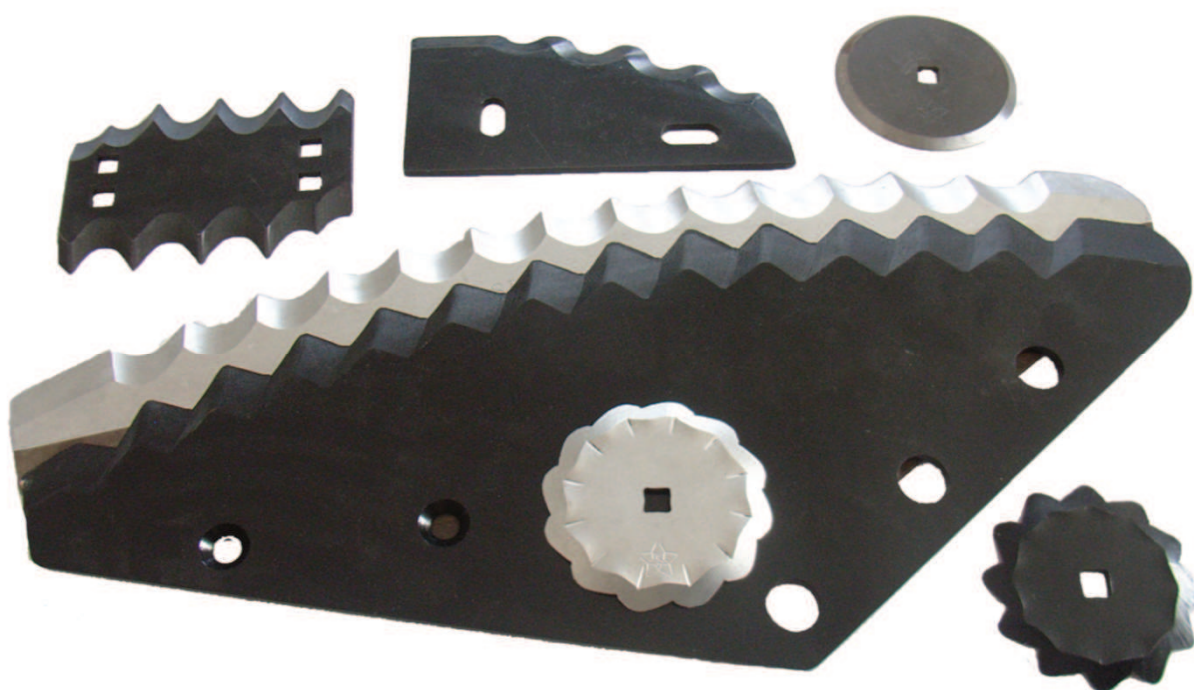

**LAME PER CARRI DESILATORI - BLADES FOR SHREDDER MIXER**  
**KLINGEN FÜR SILOSENLADER - LAMES POUR EXTRACTEUR MELANGEURS**  
**CUCHILLAS DESMENUZADORAS PARA CARROS MEZCLADORES**  
**НОЖИ ДЛЯ МИКСЕРОВ-КОРМОРАЗДАТЧИКОВ**

**Codice**

**Adattabili a:**

**Codice**

**Adattabili a:**

**D2001 L f.6,25**

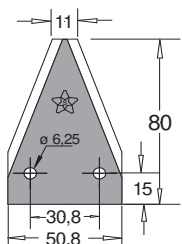

Liscia  
 Spess. 2,5  
 Varie  
 Storti 16800008  
 Mutti  
 Luclar  
 Feraboli  
 DeLaval

**D2001 L f.6,25 P**

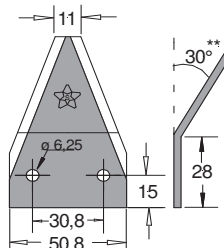

\*\* L'angolo di piegatura può essere realizzato su richiesta

Liscia  
 Spess. 2,5  
 Varie  
 Mutti  
 DeLaval

**D2001 L x 3 f.6,25**

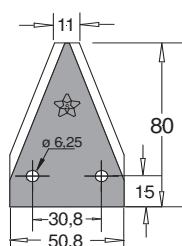

Liscia  
 Spess. 3  
 Sgariboldi  
 Luclar  
 Varie

**D2001 L x 3 f.6,25 P**

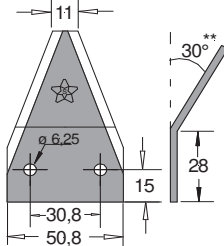

\*\* L'angolo di piegatura può essere realizzato su richiesta

Liscia  
 Spess. 3  
 Luclar  
 Varie

**D2001 L x 3 f.6,25 DX**

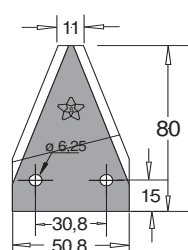

\*\* L'angolo di piegatura può essere realizzato su richiesta

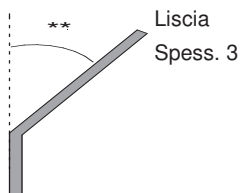

Liscia  
 Spess. 3  
 Varie

**D2001 L x 3 f.6,25 SX**

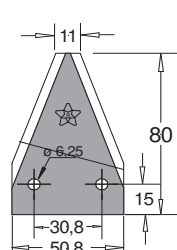

\*\* L'angolo di piegatura può essere realizzato su richiesta

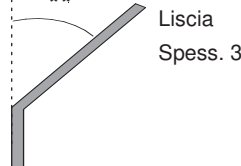

Liscia  
 Spess. 3  
 Varie

**D2001 S f.6,25**

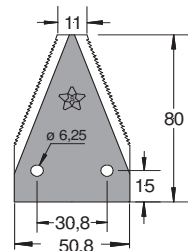

Sotto rigata  
 Spess. 2,5  
 Varie

**D2001 S x 3 f.6,25**

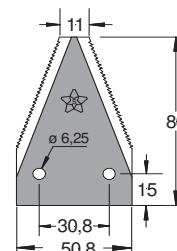

Sotto rigata  
 Spess. 3  
 Varie

**D2001 S x 3 f.8,5**

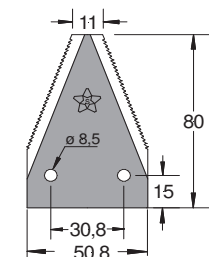

Sotto rigata  
 Spess. 3  
 Varie

**D2001 L 6 fori**

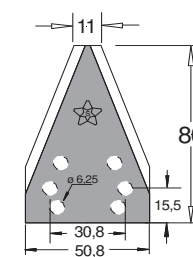

Liscia  
 Spess. 2,5  
 DeLaval 94832801  
 Storti 1680002600



**LAME PER CARRI DESILATORI - BLADES FOR SHREDDER MIXER**  
**KLINGEN FÜR SILOSENLADER - LAMES POUR EXTRACTEUR MELANGEURS**  
**CUCHILLAS DESMENUZADORAS PARA CARROS MEZCLADORES**  
**НОЖИ ДЛЯ МИКСЕРОВ-КОРМОРАЗДАТЧИКОВ**

Codice

Adattabili a:

Codice

Adattabili a:

**D2001 S x 3 f.8,5 DX**

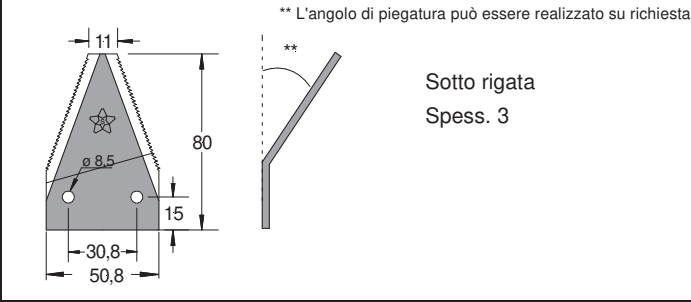

**D2001 S x 3 f.8,5 SX**

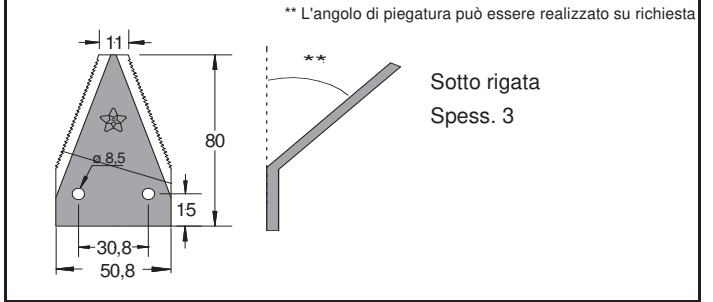

**89x3 L**

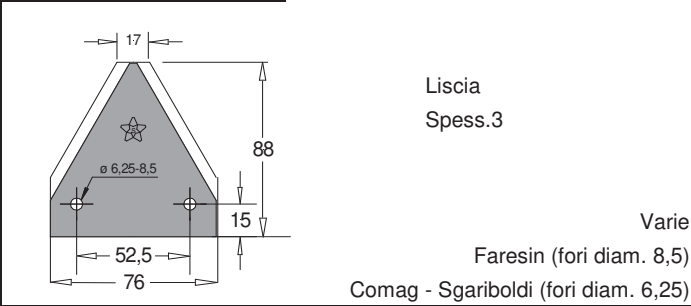

**89x3 L P**

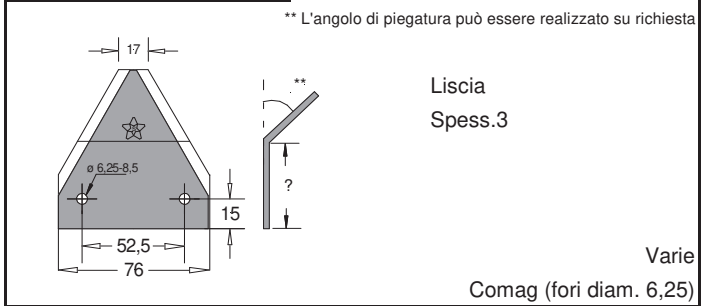

**89x4 L**

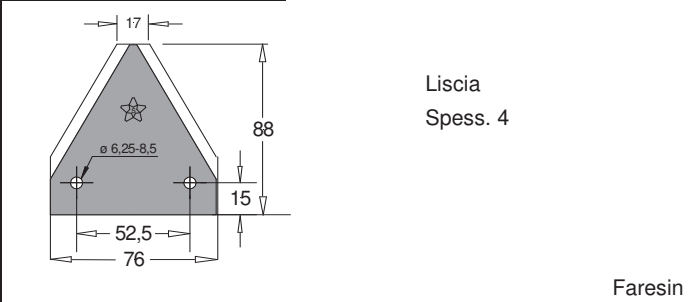

**89x4 L P**

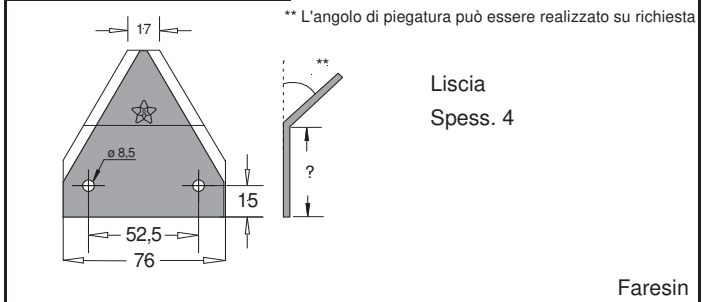

**89x3 S**

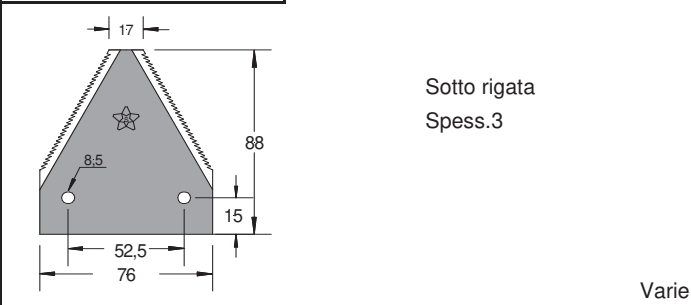

**89x3 S P**

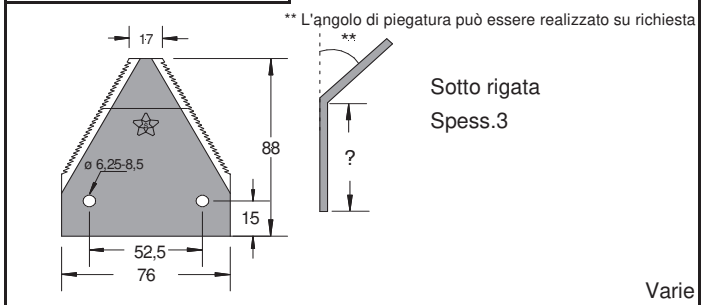

**89x3 L f.6,25 P**

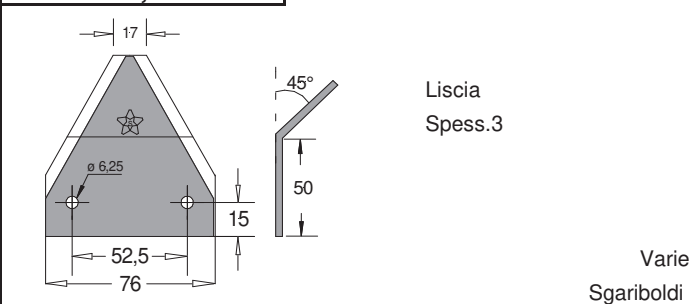

**89x3 L f.8,5 P**

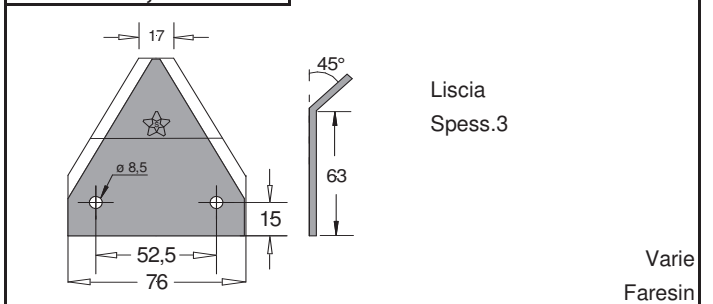

**LAME PER CARRI DESILATORI - BLADES FOR SHREDDER MIXER**  
**KLINGEN FÜR SILOSENLADER - LAMES POUR EXTRACTEUR MELANGEURS**  
**CUCHILLAS DESMENUZADORAS PARA CARROS MEZCLADORES**  
**НОЖИ ДЛЯ МИКСЕРОВ-КОРМОРАЗДАТЧИКОВ**

Codice

Adattabili a:

Codice

Adattabili a:

**89x3 L f.10,5 P 22**

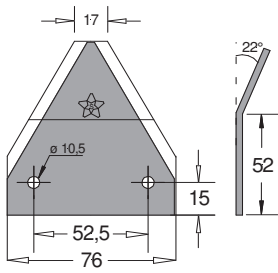

Liscia  
Spess.3

Varie

**89x3 L f.10,5 P 34**

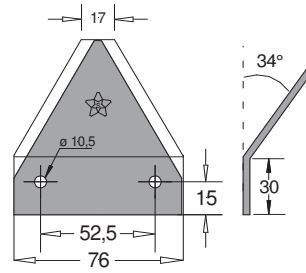

Liscia  
Spess.3

Varie

**89x3 L Dx - Sx**

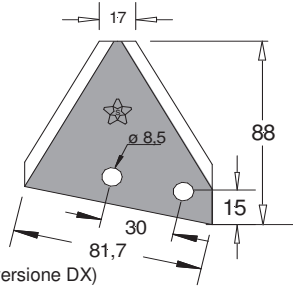

Liscia  
Spess. 3 / 4

AGM  
Unifast

**D2001L FUX**

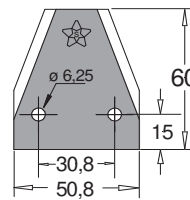

Liscia  
Spess.2,5

AGM

**212x3 L f.8,5**

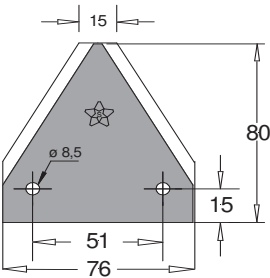

Liscia  
Spess.3

**212x3 L f.8,5 pieg.**

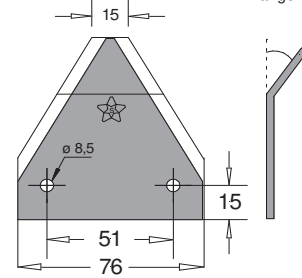

Liscia  
Spess.3

**212x3 L f.6,5**

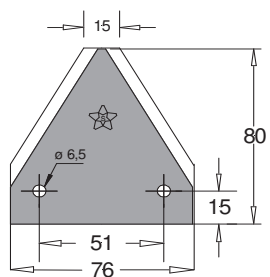

Liscia  
Spess. 3

Kuhn A7153002  
Varie

**212x3 L f.6,5 pieg.**

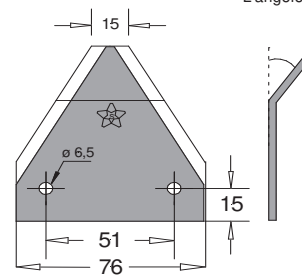

Liscia  
Spess. 3

Kuhn A7153001  
Varie

**363**

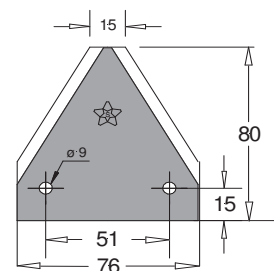

Liscia  
Spess. 3

Marmix

**362**

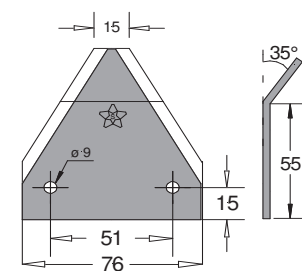

Liscia  
Spess. 3

Marmix





**LAME PER CARRI DESILATORI - BLADES FOR SHREDDER MIXER**  
**KLINGEN FÜR SILOSENLADER - LAMES POUR EXTRACTEUR MELANGEURS**  
**CUCHILLAS DESMENUZADORAS PARA CARROS MEZCLADORES**  
**НОЖИ ДЛЯ МИКСЕРОВ-КОРМОРАЗДАТЧИКОВ**

Codice

Adattabili a:

Codice

Adattabili a:

**242 P dx - sx**

**242 P dx - sx**

\*\* L'angolo di piegatura può essere realizzato su richiesta

Liscia / sotto rigata  
Spess.3

Seko 24479055 DX  
Seko 24479056 SX  
Seko 24479056 (pieg. punta)

**ROTOMIX SR**

**ROTOMIX SR**

Sopra rigata  
Spess. 2,7

Rotomix

**ST 3001**

**ST 3001**

Liscia  
Spess.4

**NEW**

Storti 16800150  
Storti 1680003001 (con riporto)

**ROTOMIX S**

**ROTOMIX S**

Sotto rigata  
Spess. 2,7

Kuhn A7153021

**ST 0029 TN**

**ST 0029 TN**

**NEW**

Storti 16800029

**ST 0129 TN**

**ST 0129 TN**

**NEW**

Storti 16800129

**ST 7153021**

**ST 7153021**

Liscia  
Spess.4

**NEW**

Kuhn A7153021

**ST604206 P60° TN**

**ST604206 P60° TN**

**NEW**

Siloking 604206

**ST 704229**

**ST 704229**

**NEW**

Silage excluding  
Keenan 704229

**ST 1350 TN**

**ST 1350 TN**

**NEW**

Guaresi 19078



**LAME PER CARRI DESILATORI - BLADES FOR SHREDDER MIXER**  
**KLINGEN FÜR SILOSENLADER - LAMES POUR EXTRACTEUR MELANGEURS**  
**CUCHILLAS DESMENUZADORAS PARA CARROS MEZCLADORES**  
**НОЖИ ДЛЯ МИКСЕРОВ-КОРМОРАЗДАТЧИКОВ**

Codice

Adattabili a:

Codice

Adattabili a:

**DISCO 95**

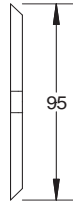

Spess. 5  
 Foro 11 x 11 Sgariboldi  
 Himel 3001689  
 Pagliari - Marmix  
 Luclar - Eurocomp  
 Supertino - Tatoma  
 Storti 1680020  
 Frasto 16800020 - Walker  
 DeLaval 94832401

**DISCO DENTATO 95**



Spess. 5  
 Foro 11 x 11  
 Himel  
 Tatoma  
 Storti 16800014  
 Frasto 16800014 - Walker  
 Kverneland

**DISCO DENTATO SK**

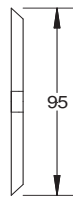
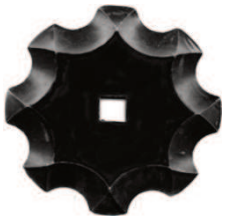

Spess. 5  
 Foro 11 x 11

**DISCO DENTATO SK - diam.140**

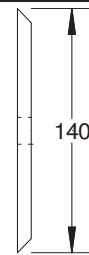
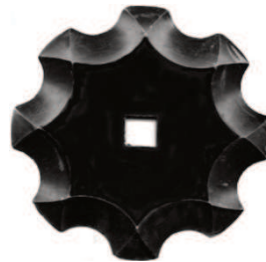

Spess. 8  
 Foro 16,5 x 16,5

**COLTELLO OVALE DENTATO**



Spess. 5

Storti 16800139

**DISCO MARGHERITA diam. 95**

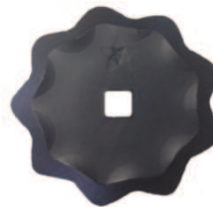

Spess. 5  
 Foro 11 x 11

Varie

**COLTELLO OVALE DENTATO DIAM. 110**



Storti 16800171

**ALETTA DX-SX**

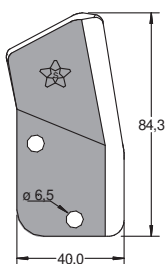

Spess. 3  
 Foro Ø 6,5

(versione SX)

Storti 16800012-13

**ALETTA DX-SX**

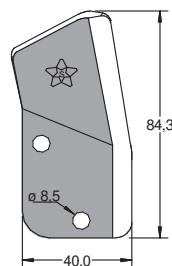

Spess. 4  
 Foro Ø 8,5

(versione SX)



**LAME PER CARRI DESILATORI - BLADES FOR SHREDDER MIXER**  
**KLINGEN FÜR SILOSENLADER - LAMES POUR EXTRACTEUR MELANGEURS**  
**CUCHILLAS DESMENUZADORAS PARA CARROS MEZCLADORES**  
**НОЖИ ДЛЯ МИКСЕРОВ-КОРМОРАЗДАТЧИКОВ**

Codice

Adattabili a:

Codice

Adattabili a:

**CM 0001 SX**

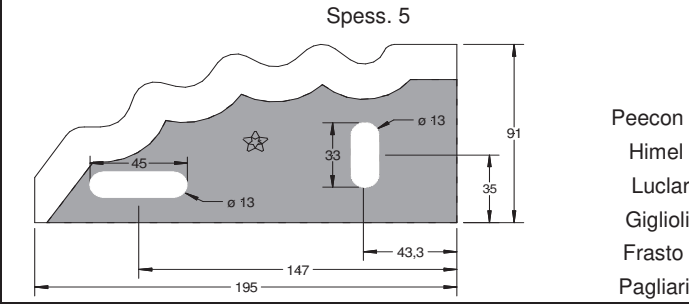

Peecon  
Himel  
Luclar  
Giglioli  
Frasto  
Pagliari

**CM 0001 DX**

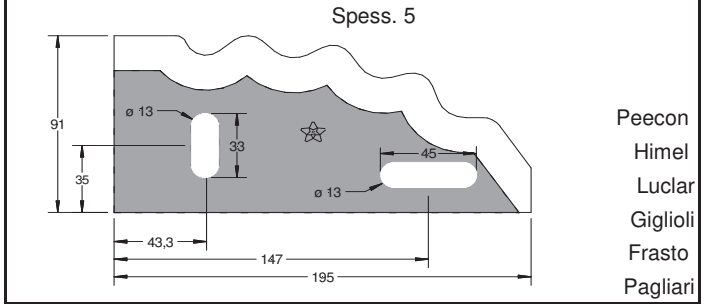

Peecon  
Himel  
Luclar  
Giglioli  
Frasto  
Pagliari

**CM 0001 / L 180 SX**

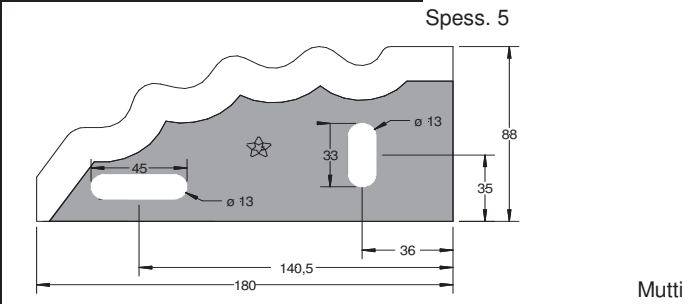

Mutti

**CM 0001 / L 180 DX**

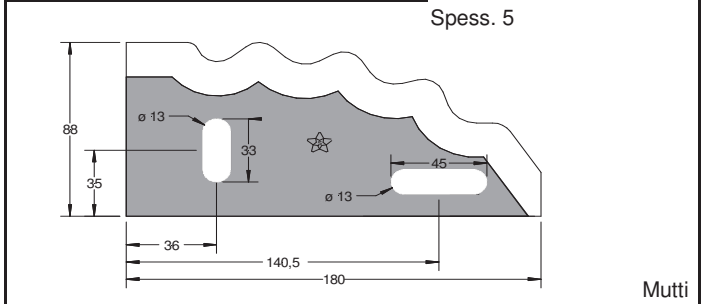

Mutti

**CM 0003 SX**

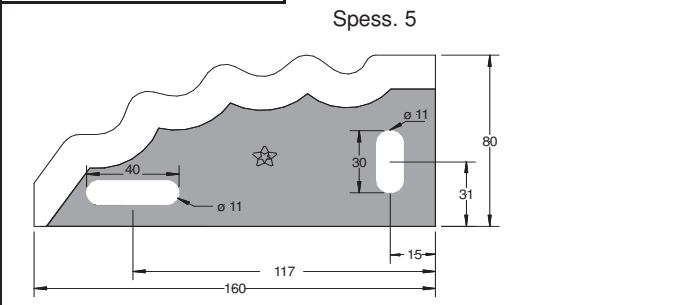

**CM 0003 DX**

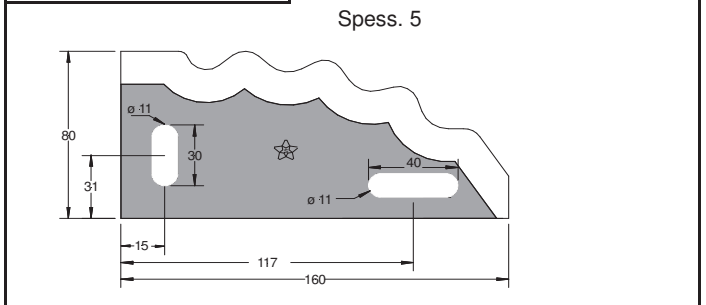

**CM 0006 SX**

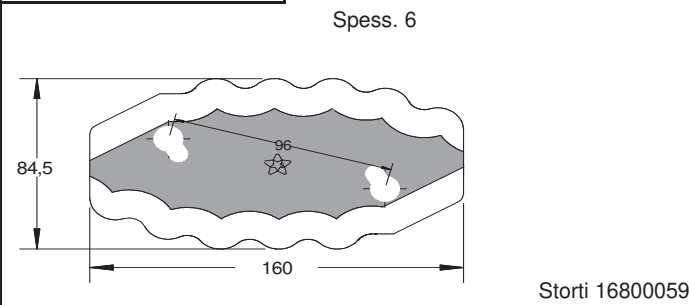

Storti 16800059

**CM 0006 DX**

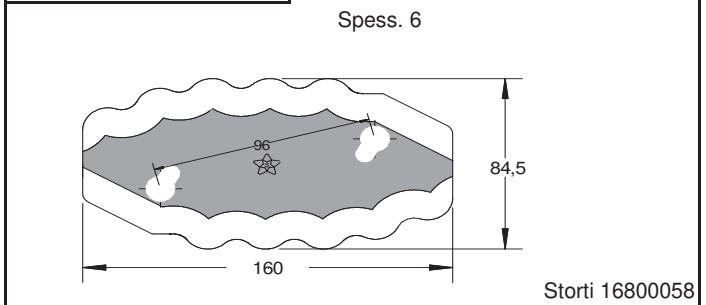

Storti 16800058

**ST 0061**

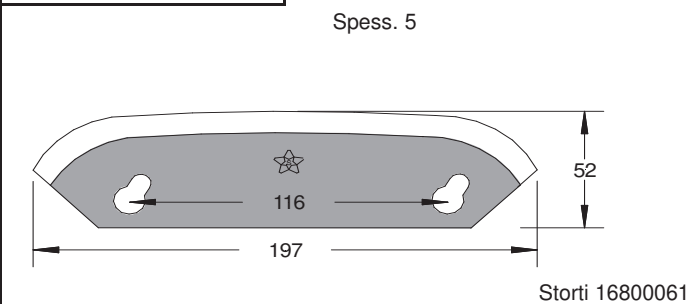

Storti 16800061

**ST 00160**

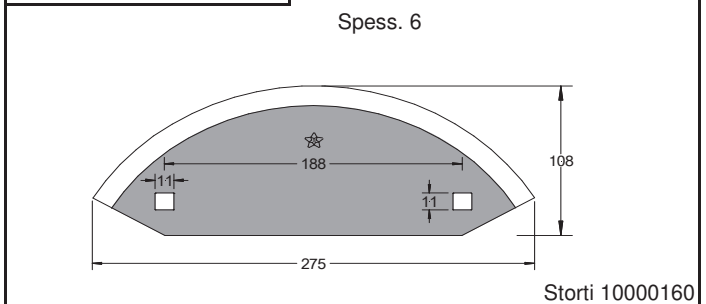

Storti 10000160



**LAME PER CARRI DESILATORI - BLADES FOR SHREDDER MIXER**  
**KLINGEN FÜR SILOSENLADER - LAMES POUR EXTRACTEUR MELANGEURS**  
**CUCHILLAS DESMENUZADORAS PARA CARROS MEZCLADORES**  
**НОЖИ ДЛЯ МИКСЕРОВ-КОРМОРАЗДАТЧИКОВ**

Codice

Adattabili a:

Codice

Adattabili a:

**ST 00133**

Spess. 6

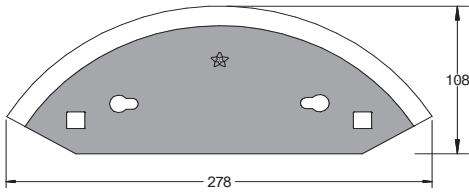

Storti 16800133

**CMF 0020**

Spess. 5

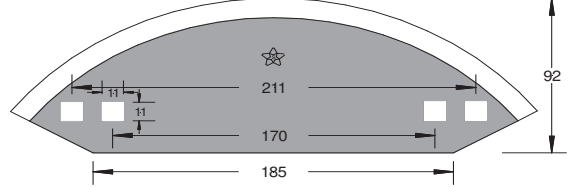

Faresin

**CMF 0021 SX**

Spess. 5 / 6

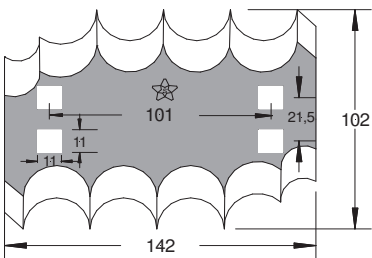

Faresin 30840.8750

**CMF 0021 DX**

Spess. 5 / 6

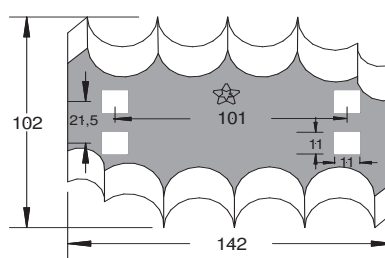

Faresin 30845.9950

**CMS 0005 SX**

Spess. 5

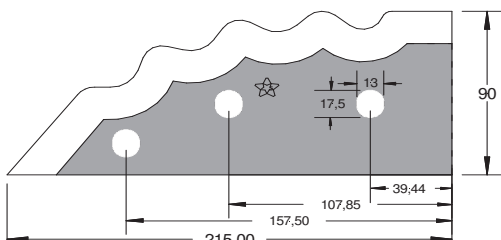

Sgariboldi CL04.008

**CMS 0005 DX**

Spess. 5

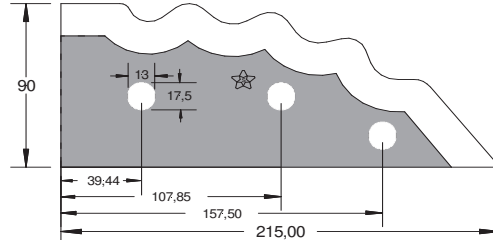

Sgariboldi CL04.014

**CM 0002**

Spess. 5

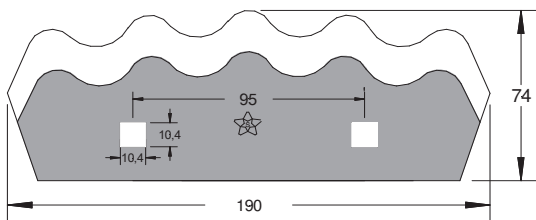

Marmix

**CM 0008**

Spess. 5

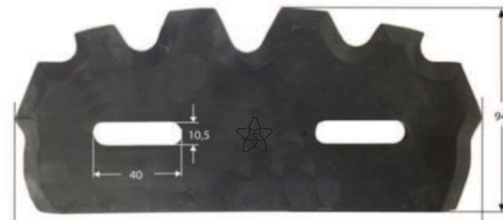

Giglioli

**CM 0009 T**

Spess. 5

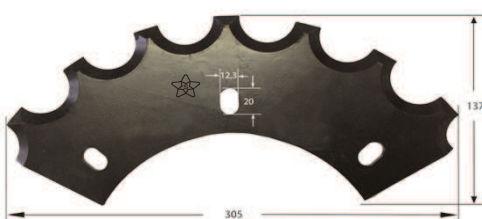

Tatoma MR-090-06

**ST 703954 SX**

**ST 703955 DX**

Spess. 5



Keenan 703955  
Keenan 703954



**LAME PER CARRI DESILATORI - BLADES FOR SHREDDER MIXER**  
**KLINGEN FÜR SILOSENLADER - LAMES POUR EXTRACTEUR MELANGEURS**  
**CUCHILLAS DESMENUZADORAS PARA CARROS MEZCLADORES**  
**НОЖИ ДЛЯ МИКСЕРОВ-КОРМОРАЗДАТЧИКОВ**

Codice

Adattabili a:

Codice

Adattabili a:

**ST 703956 SX**

**ST 703957 DX**



**ST 701359 SX**

**ST 701358 DX**

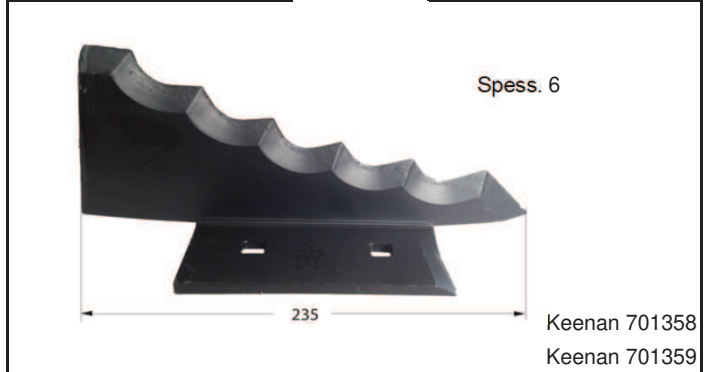

**RRC 210x220**

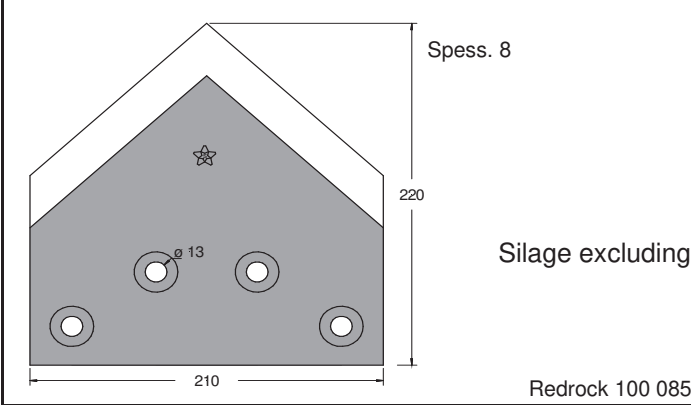

**RRS 160x220**

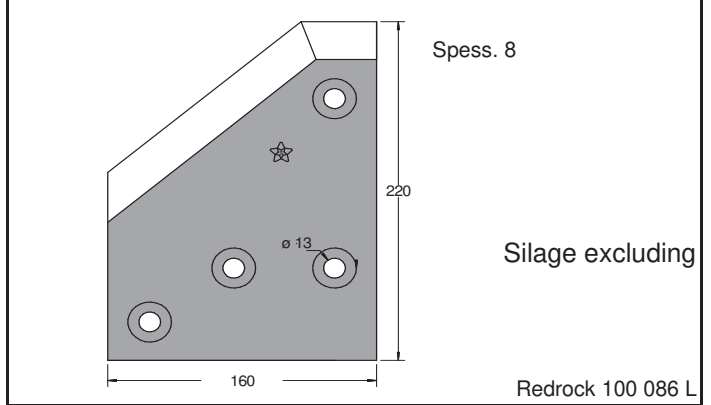

**RRD 160x220**

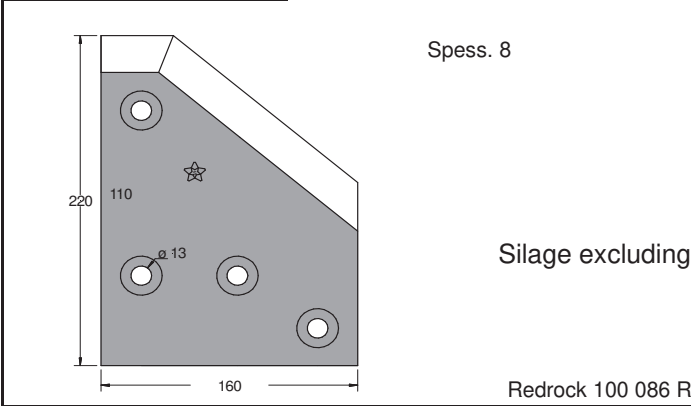

**COLTELLO TR**



**ST 7153012**

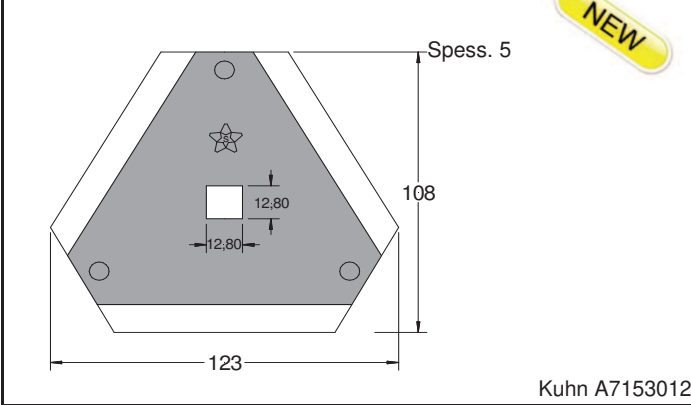

**ST 5306460**

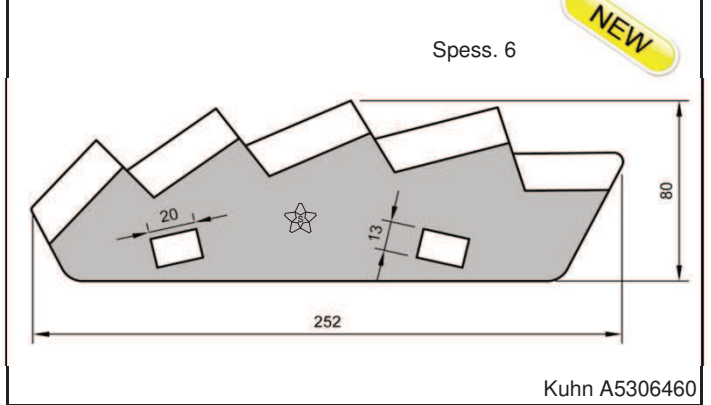

**LAME PER CARRI DESILATORI - BLADES FOR SHREDDER MIXER**  
**KLINGEN FÜR SILOSENLADER - LAMES POUR EXTRACTEUR MELANGEURS**  
**CUCHILLAS DESMENUZADORAS PARA CARROS MEZCLADORES**  
**НОЖИ ДЛЯ МИКСЕРОВ-КОРМОРАЗДАТЧИКОВ**

Codice

Adattabili a:

Codice

Adattabili a:

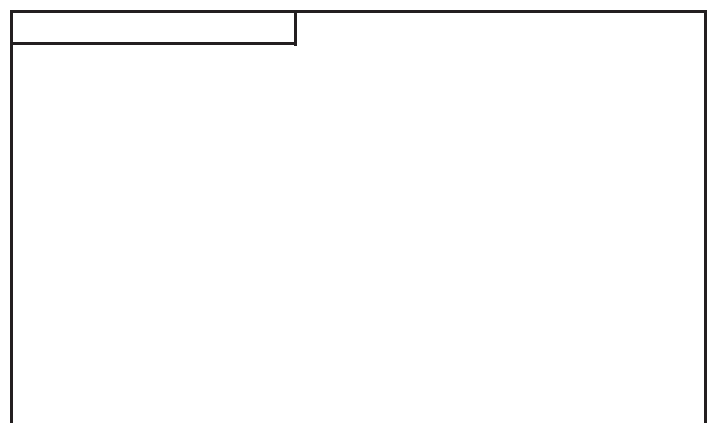
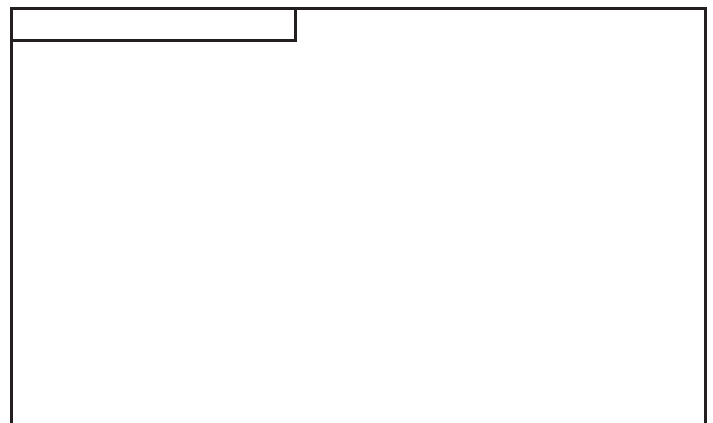
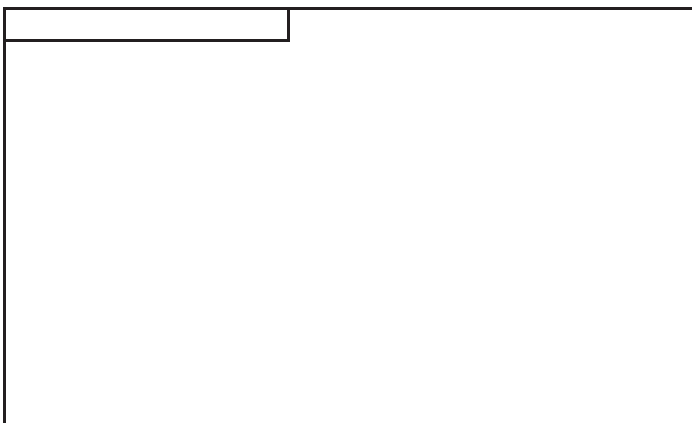
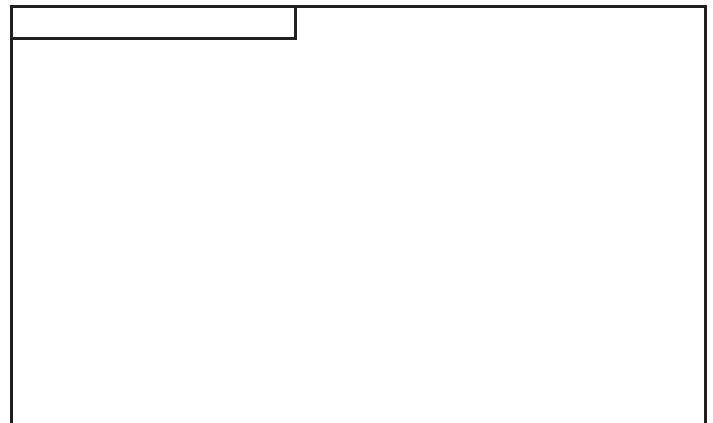
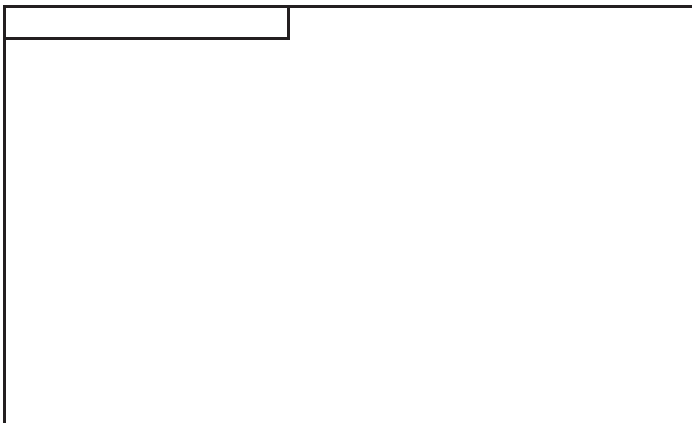
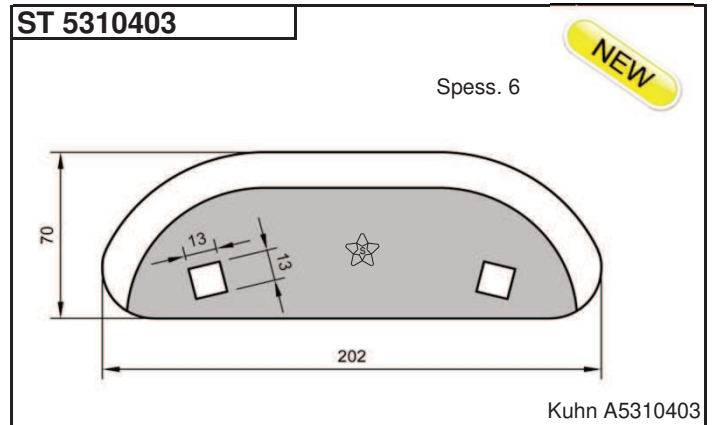
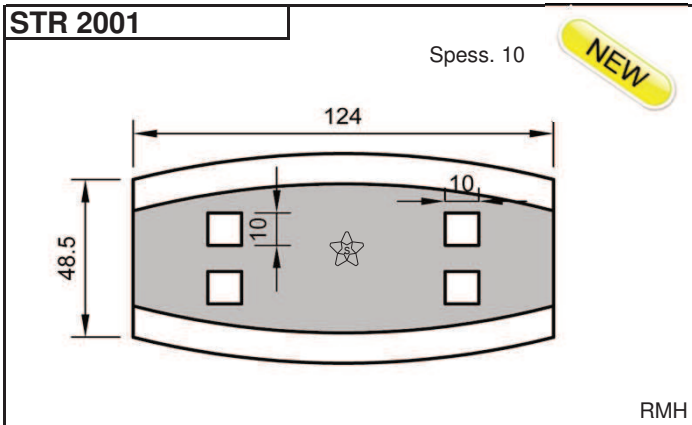

**LAME PER CARRI DESILATORI - BLADES FOR SHREDDER MIXER**  
**KLINGEN FÜR SILOSENLADER - LAMES POUR EXTRACTEUR MELANGEURS**  
**CUCHILLAS DESMENUZADORAS PARA CARROS MEZCLADORES**  
**НОЖИ ДЛЯ МИКСЕРОВ-КОРМОРАЗДАТЧИКОВ**

Codice

Adattabili a:

Codice

Adattabili a:

**CMV 0004 - Platinum**

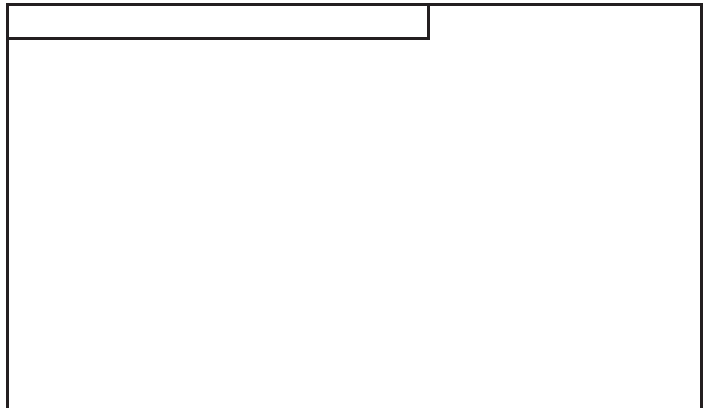
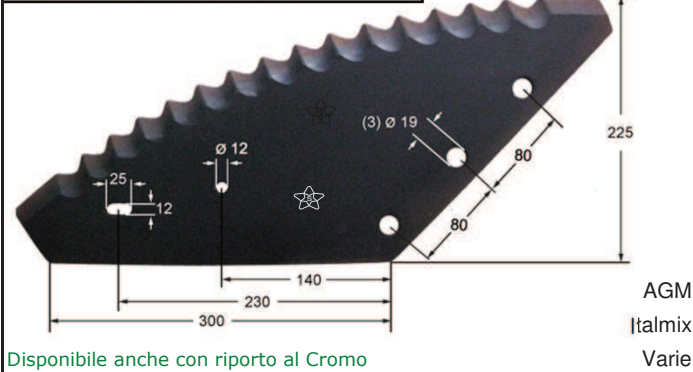

**CMV 0007 SX - Standard**

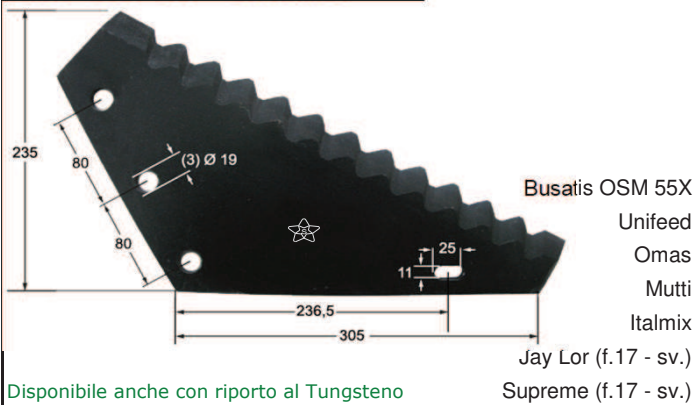

**CMV 0007 DX - Standard**

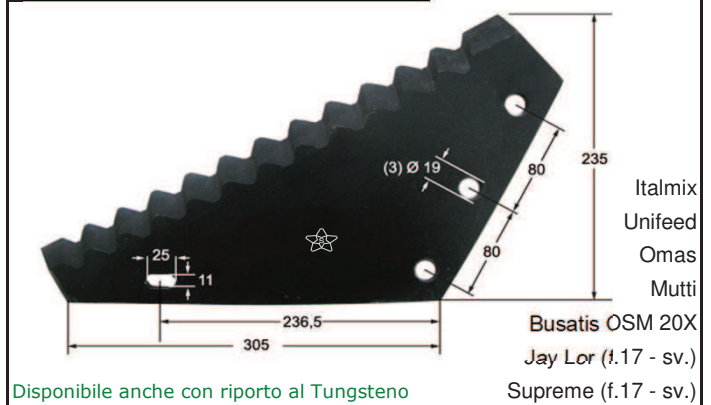

**CMV 0007 SX - Platinum**

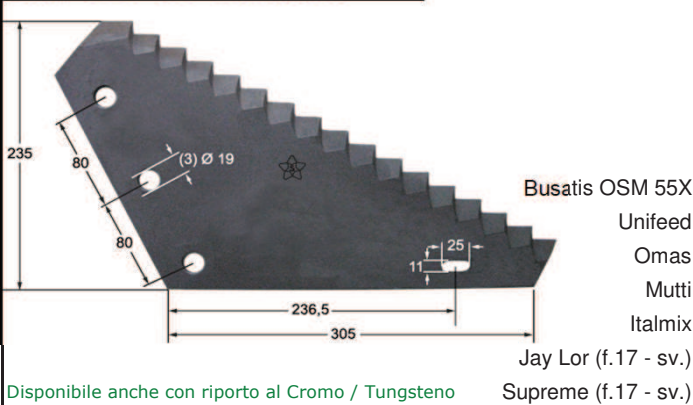

**CMV 0007 DX - Platinum**

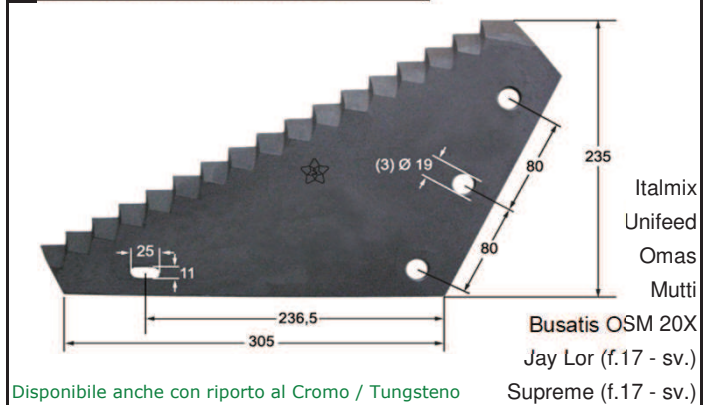

**CMV 0009 SX - Standard**

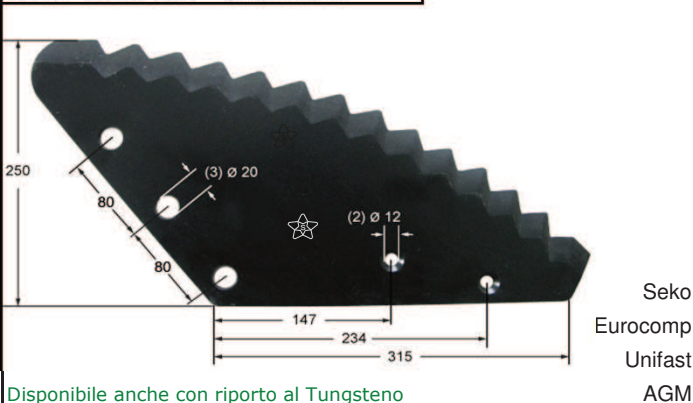

**CMV 0009 DX - Standard**



**LAME PER CARRI DESILATORI - BLADES FOR SHREDDER MIXER**  
**KLINGEN FÜR SILOSENLADER - LAMES POUR EXTRACTEUR MELANGEURS**  
**CUCHILLAS DESMENUZADORAS PARA CARROS MEZCLADORES**  
**НОЖИ ДЛЯ МИКСЕРОВ-КОРМОРАЗДАТЧИКОВ**

Codice

Adattabili a:

Codice

Adattabili a:

**CMV 0009 SX - Platinum**

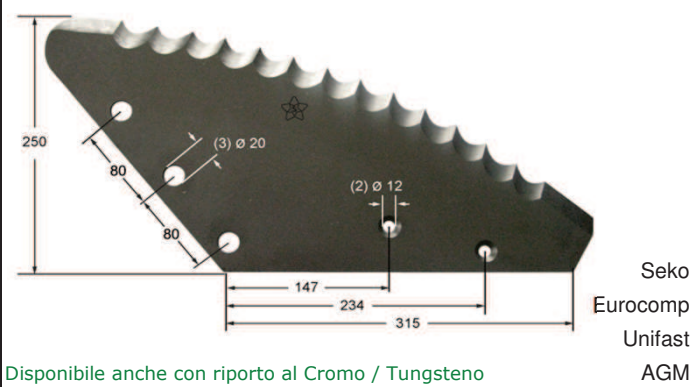

Disponibile anche con riporto al Cromo / Tungsteno

**CMV 0009 DX - Platinum**

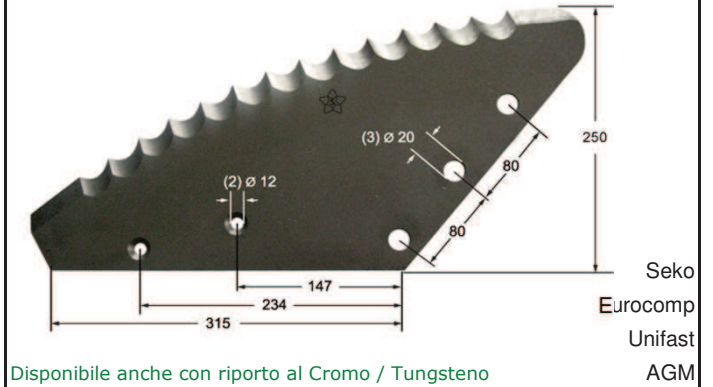

Disponibile anche con riporto al Cromo / Tungsteno

**CMV 0010 SX - Standard**

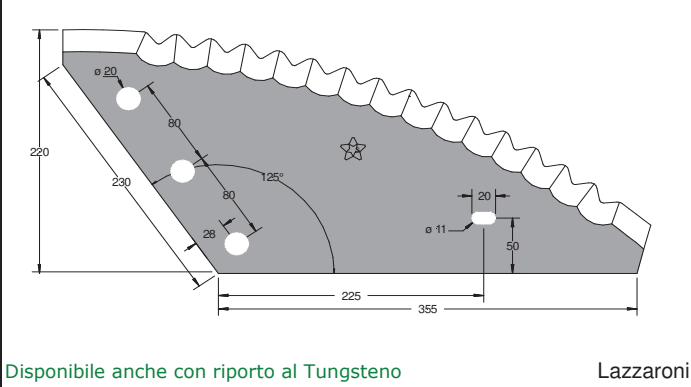

Disponibile anche con riporto al Tungsteno

**CMV 0010 DX - Standard**

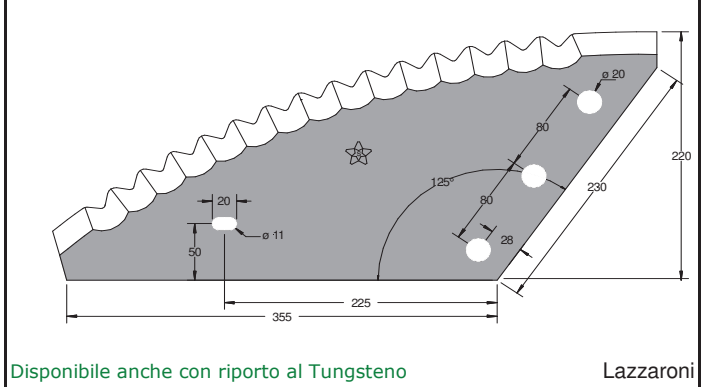

Disponibile anche con riporto al Tungsteno

**CMV 0011 SX - Platinum**

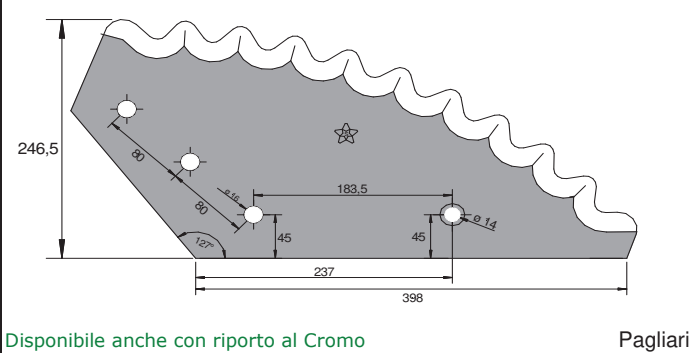

Disponibile anche con riporto al Cromo

**CMV 0011 DX - Platinum**

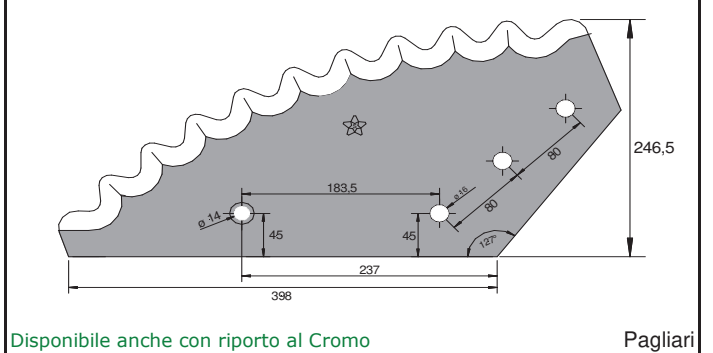

Disponibile anche con riporto al Cromo

**CMV 0012 - Platinum**

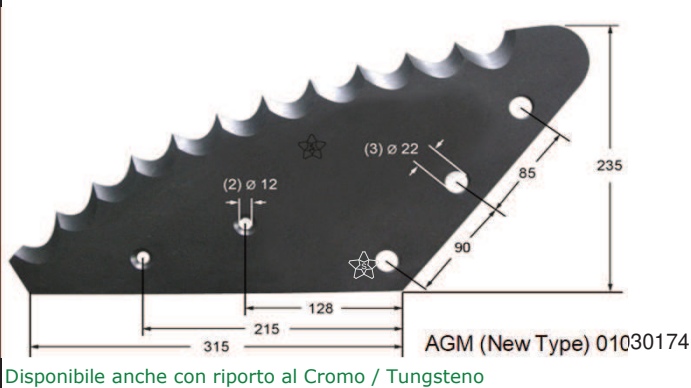

Disponibile anche con riporto al Cromo / Tungsteno

**CMV 0015**

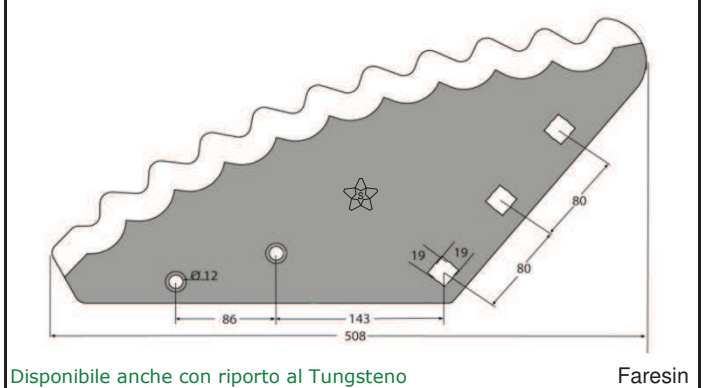

Disponibile anche con riporto al Tungsteno





**LAME PER CARRI DESILATORI - BLADES FOR SHREDDER MIXER**  
**KLINGEN FÜR SILOSENLADER - LAMES POUR EXTRACTEUR MELANGEURS**  
**CUCHILLAS DESMENUZADORAS PARA CARROS MEZCLADORES**  
**НОЖИ ДЛЯ МИКСЕРОВ-КОРМОРАЗДАТЧИКОВ**

Codice

Adattabili a:

Codice

Adattabili a:

**CMV 0014 SX - Standard**



Disponibile anche con riporto al Tungsteno

Supertino

**CMV 0014 DX - Standard**



Disponibile anche con riporto al Tungsteno

Supertino

**CMV 0016**

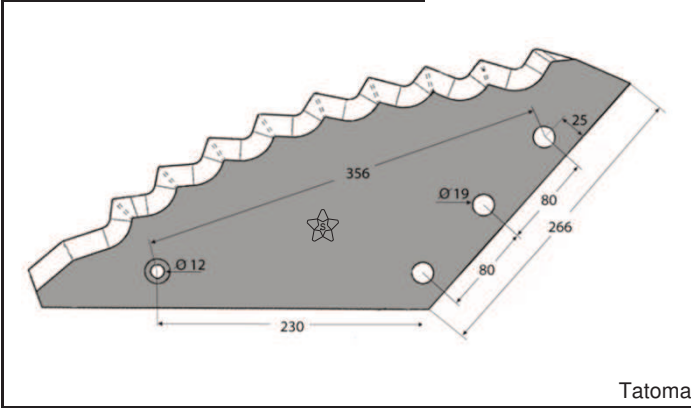

Tatoma

**CMV 0018**

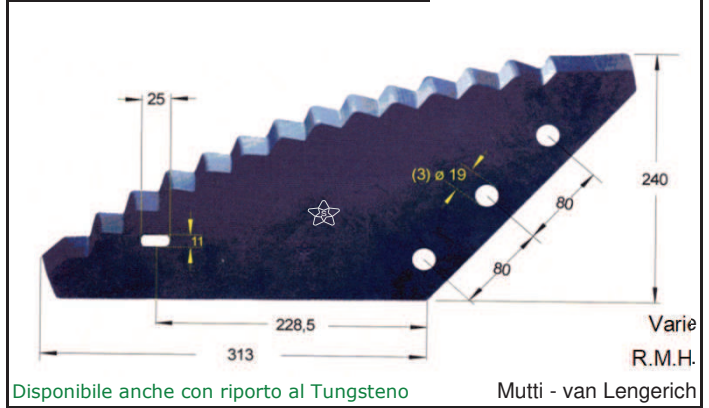

Disponibile anche con riporto al Tungsteno

Varie R.M.H. Mutti - van Lengerich

**CMV 0019**

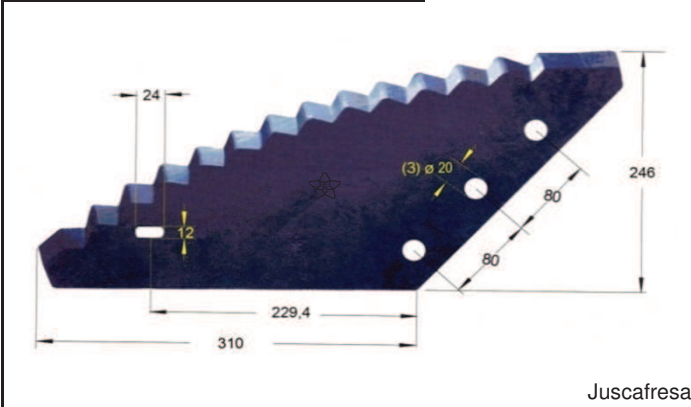

Juscafresa

**CMV 0020**

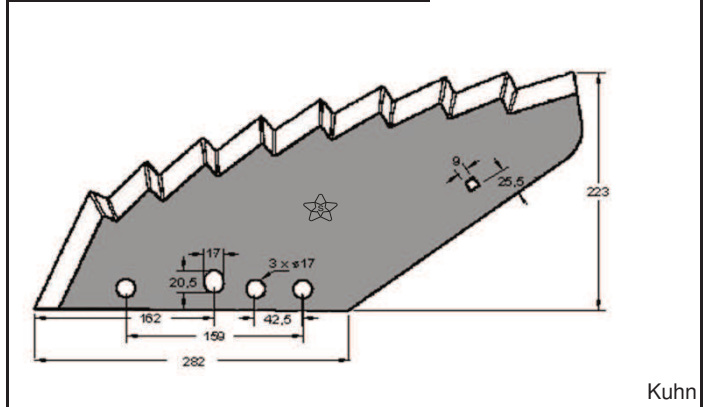

Kuhn

**CMV 0021**

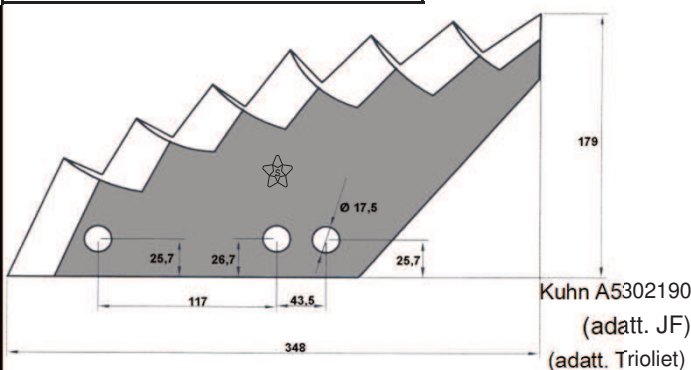

Kuhn A5302190  
(adatt. JF)  
(adatt. Trioliet)

**CMV 0022**

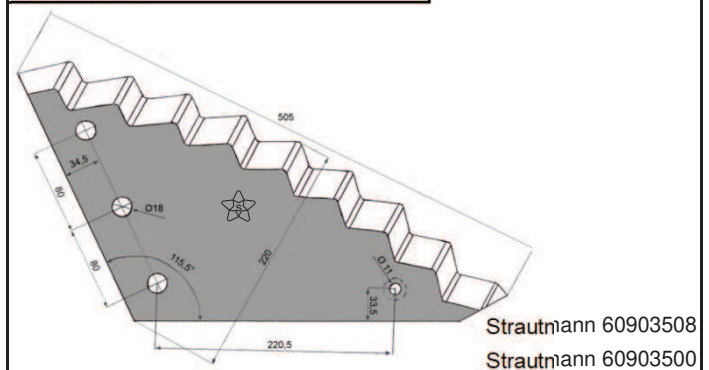

Strautmann 60903508  
Strautmann 60903500



**LAME PER CARRI DESILATORI - BLADES FOR SHREDDER MIXER**  
**KLINGEN FÜR SILOSENLADER - LAMES POUR EXTRACTEUR MELANGEURS**  
**CUCHILLAS DESMENUZADORAS PARA CARROS MEZCLADORES**  
**НОЖИ ДЛЯ МИКСЕРОВ-КОРМОРАЗДАТЧИКОВ**

Codice

Adattabili a:

Codice

Adattabili a:

**CMV 0023**

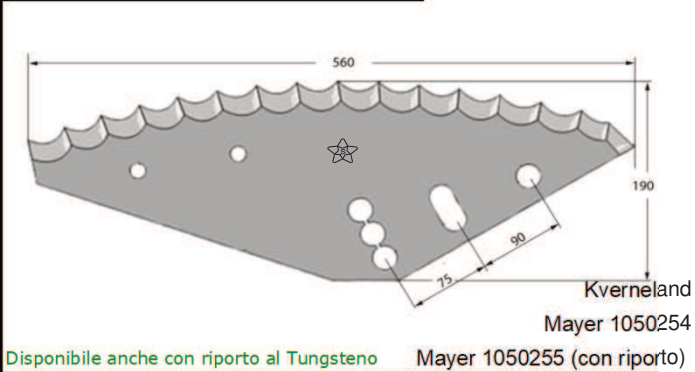

Disponibile anche con riporto al Tungsteno Mayer 1050255 (con riporto)

**CMV 0023 JEANTIL**

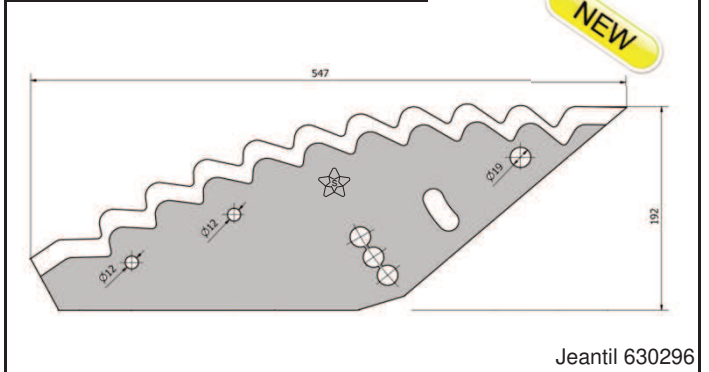

Jeantil 630296

**CMV 0024**

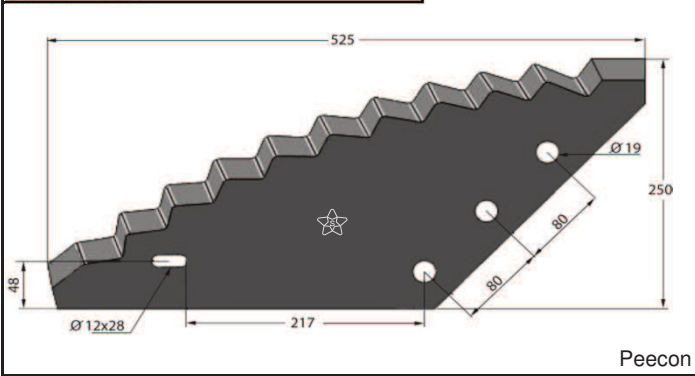

Peecon

**CMV 0025 TN**

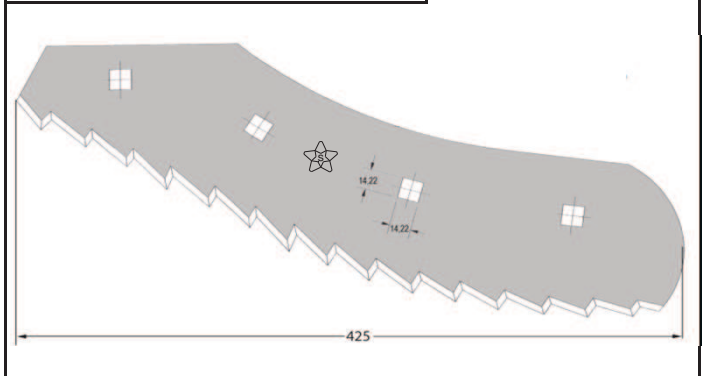

Con riporto al Tungsteno

Jay Lor

**CMV 0026 TN**

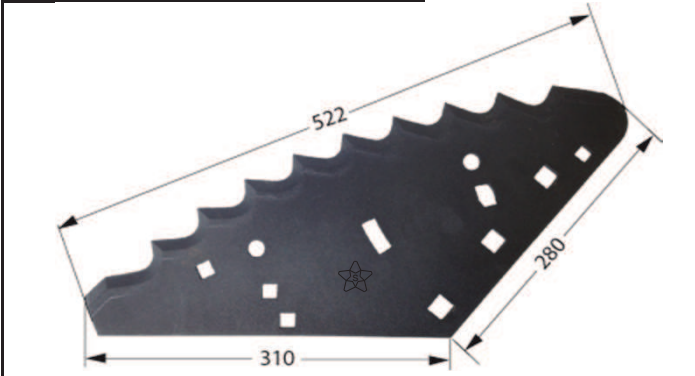

Con riporto al Tungsteno

Penta

**CMV 0027**

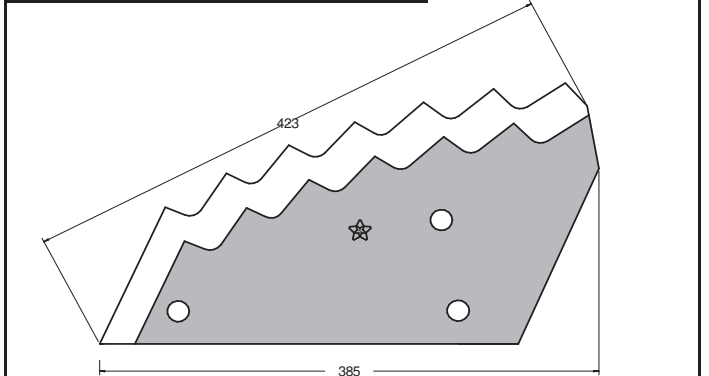

Kuhn 006-70147065

**CMV 0028**

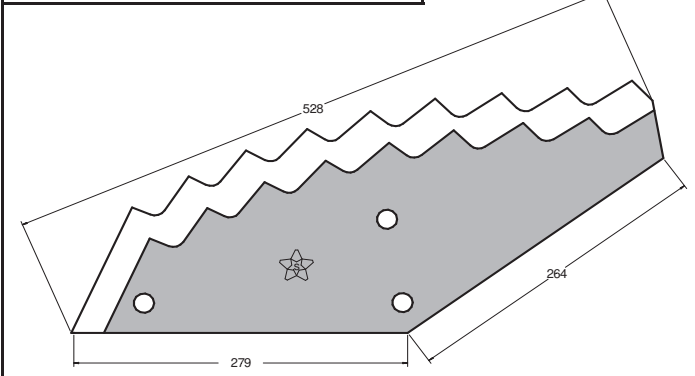

Kuhn 023-70144734

**CMV 0029**

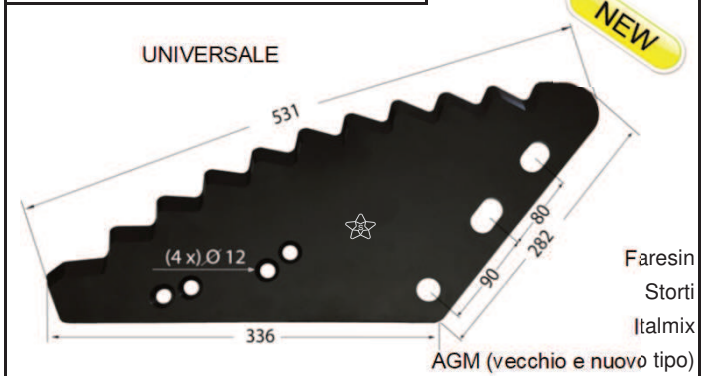

Disponibile anche con riporto al Cromo / Tungsteno

General Mix



**LAME PER CARRI DESILATORI - BLADES FOR SHREDDER MIXER**  
**KLINGEN FÜR SILOSENLADER - LAMES POUR EXTRACTEUR MELANGEURS**  
**CUCHILLAS DESMENUZADORAS PARA CARROS MEZCLADORES**  
**НОЖИ ДЛЯ МИКСЕРОВ-КОРМОРАЗДАТЧИКОВ**

Codice

Adattabili a:

Codice

Adattabili a:

**CMV 00155**



**ST 16200**



**CMV 0035**



**CMV 0046 TN**

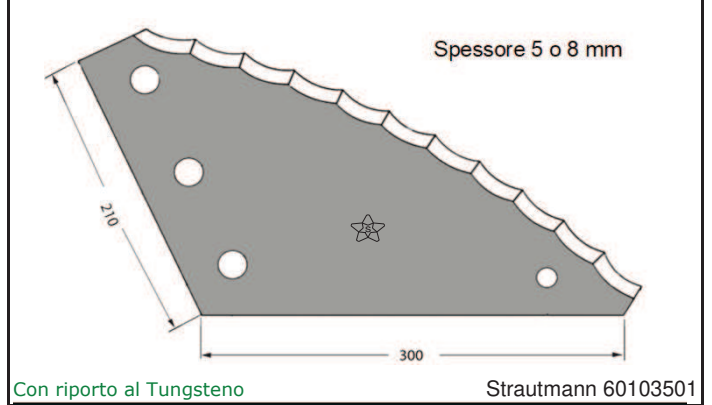

**CMV 0047**

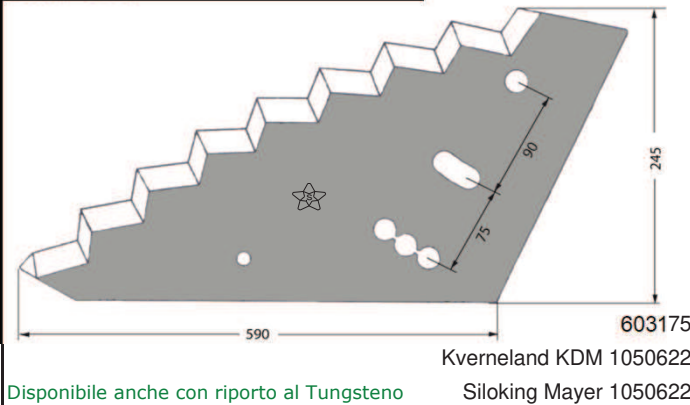

**CMV 0030**

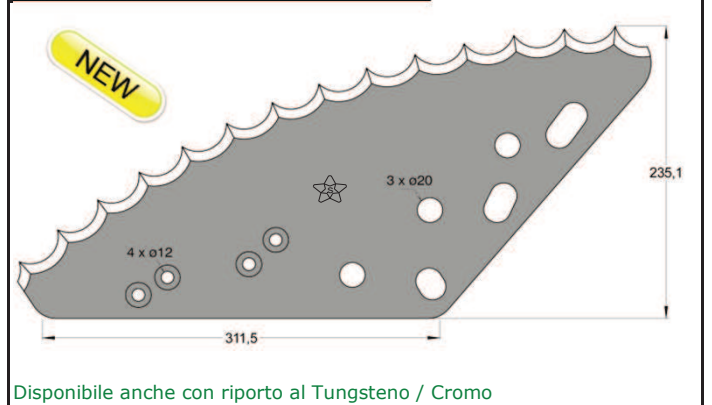

**CMV 0048**

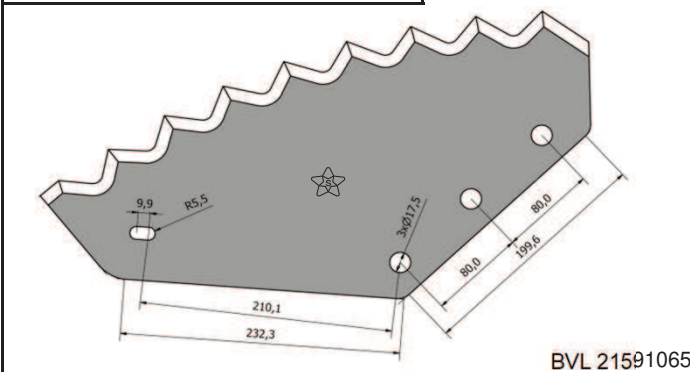

**ST 05945**



**ST 05818**



**LAME PER CARRI DESILATORI - BLADES FOR SHREDDER MIXER**  
**KLINGEN FÜR SILOSENLADER - LAMES POUR EXTRACTEUR MELANGEURS**  
**CUCHILLAS DESMENUZADORAS PARA CARROS MEZCLADORES**  
**НОЖИ ДЛЯ МИКСЕРОВ-КОРМОРАЗДАТЧИКОВ**

Codice

Adattabili a:

Codice

Adattabili a:

**CMV 0057**

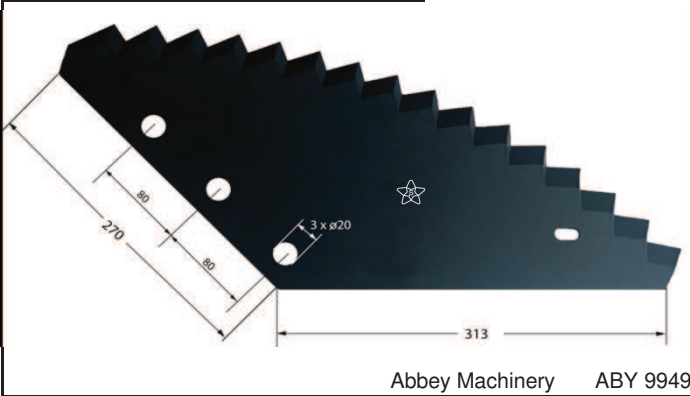

**CMV 0049**

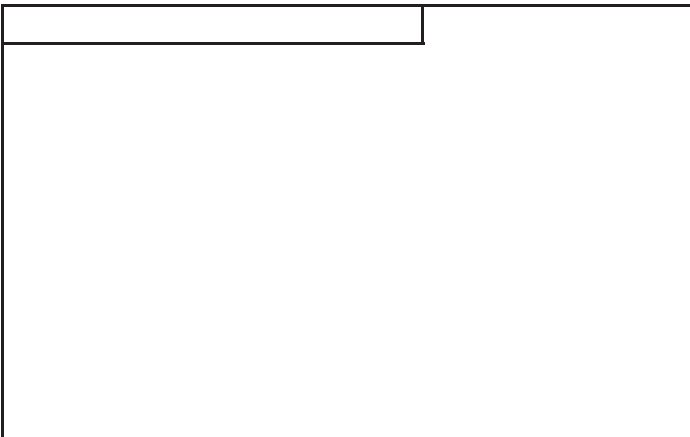
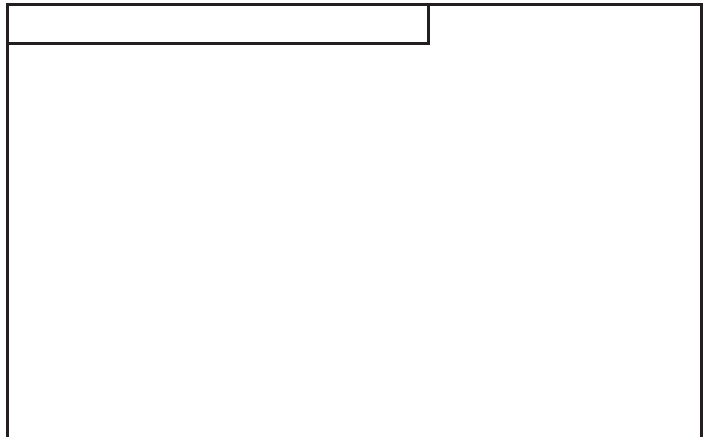
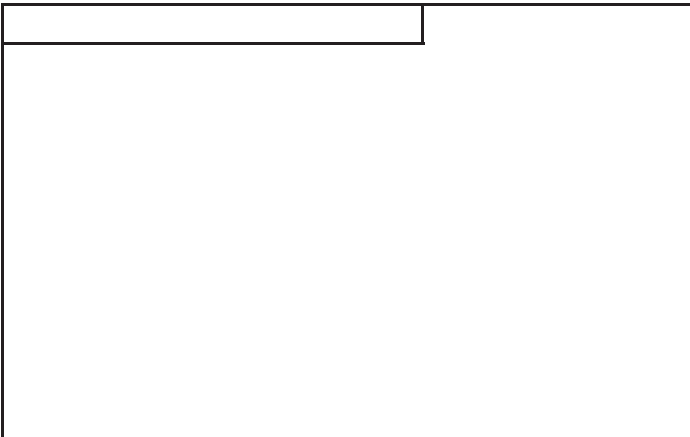
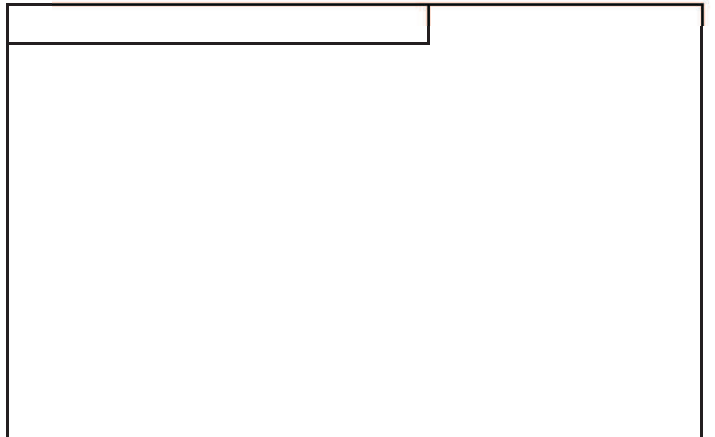
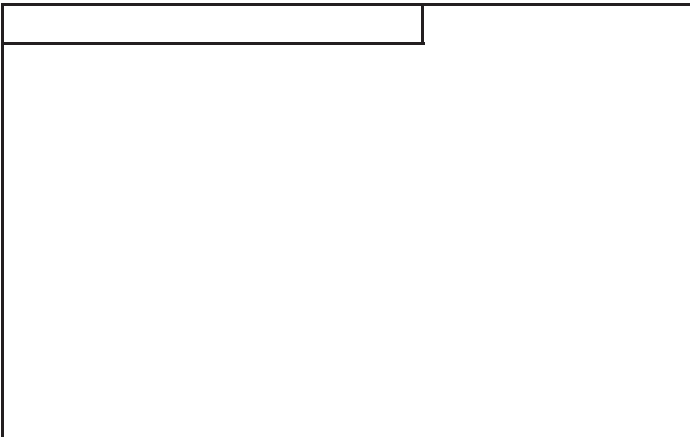
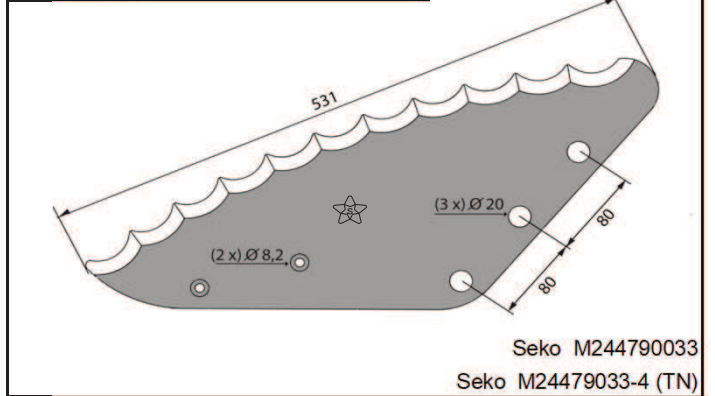

# COLTELLI PER ROTOPRESSE / AUTOCARICANTI

[www.stellalame.com](http://www.stellalame.com)



**COLTELLI PER ROTOPRESSE- KNIVES FOR ROUND BALERS**  
**COUTEAUX POUR PRESSES DES BALLEES CYLINDRIQUES - MESSER FÜR BALLENPRESSEN**  
**CUCHILLAS ROTOEMPACADORA - НОЖИ ДЛЯ ПРЕСС-ПОДБОРЩИКА**

Codice

Adattabili a:

Codice

Adattabili a:

**ROT 0065**



Claas 837779.0

**ROT 0067**



Claas 823422.1

**ROT 0084**



Claas 8510220  
 Claas 845093.0

**ROT 0100**



immagine non disponibile

Claas 8661240  
 Claas 8661250 (TN)

**ROT 0109**

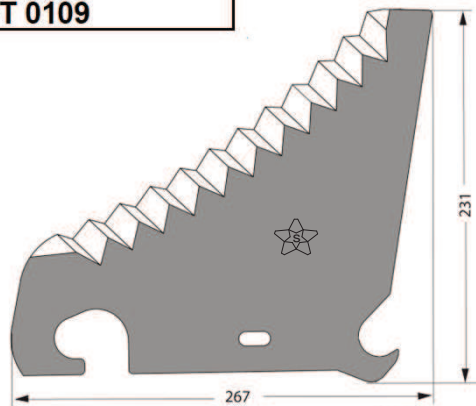

Case 84056426

**ROT 0072**

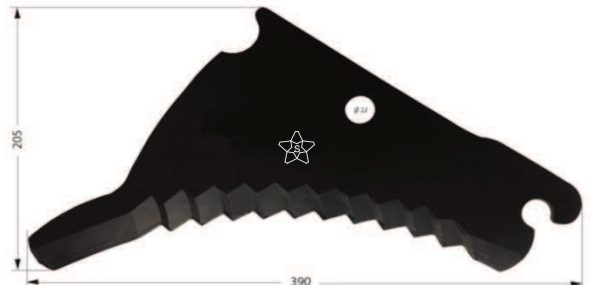

Kuhn Z4079940  
 Deutz Fahr 1665 3188 (TN)  
 Deutz Fahr 1661 3168

**ROT 0071**



Deutz Fahr 1665 0699

**ROT 0054**

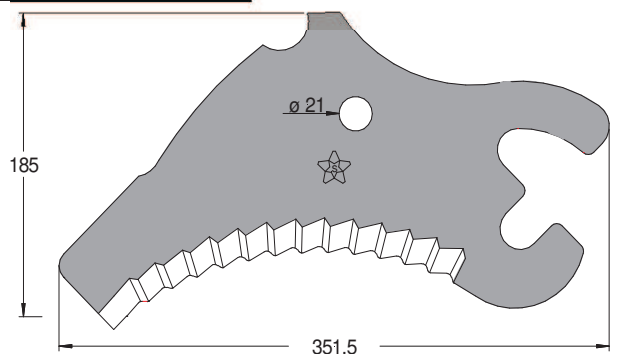

Feraboli 7U00035



**COLTELLI PER ROTOPRESSE- KNIVES FOR ROUND BALERS**  
**COUTEAUX POUR PRESSES DES BALLEES CYLINDRIQUES - MESSER FÜR BALLENPRESSEN**  
**CUCHILLAS ROTOEMPACADORA - НОЖИ ДЛЯ ПРЕСС-ПОДБОРЩИКА**

Codice

Adattabili a:

Codice

Adattabili a:

**ROT 0053**

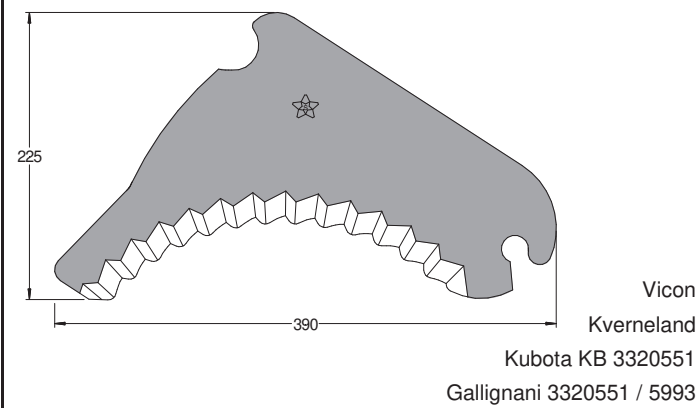

**ROT 0079**



**ROT 0080**



**ROT 0081**



**ROT 0104**



**ROT 0128**



**ROT 0051**

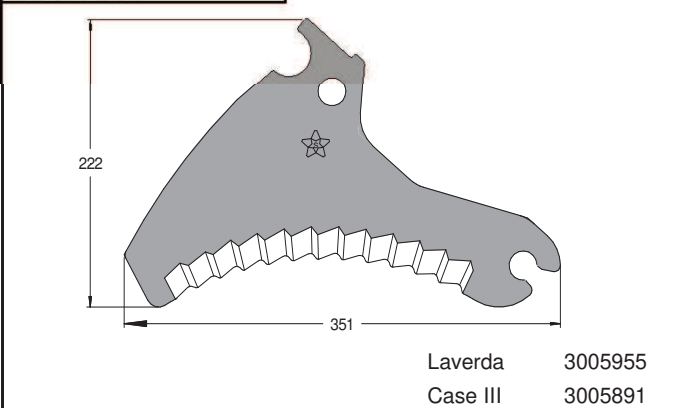

**ROT 0085**

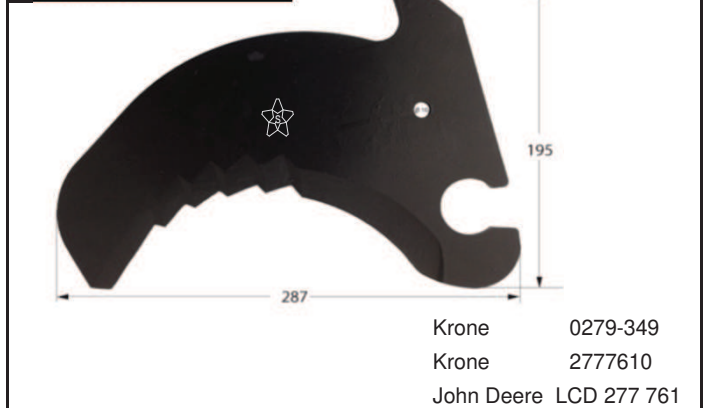

**COLTELLI PER ROTOPRESSE- KNIVES FOR ROUND BALERS**  
**COUTEAUX POUR PRESSES DES BALLEES CYLINDRIQUES - MESSER FÜR BALLENPRESSEN**  
**CUCHILLAS ROTOEMPACADORA - НОЖИ ДЛЯ ПРЕСС-ПОДБОРЩИКА**

Codice

Adattabili a:

Codice

Adattabili a:

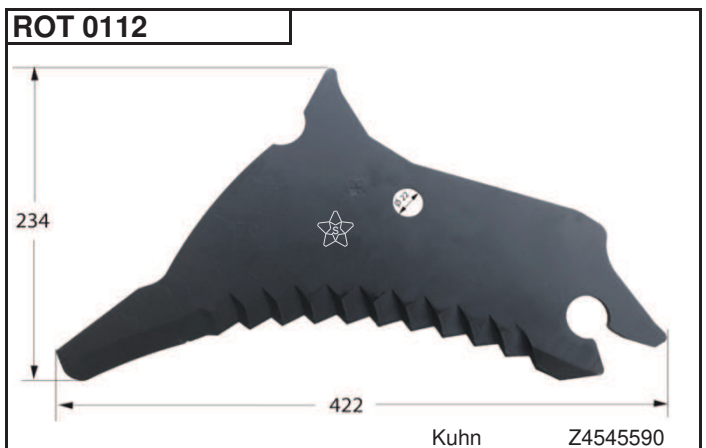
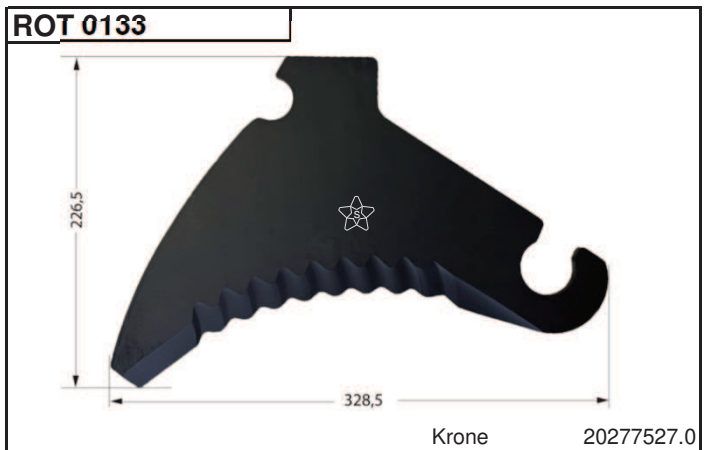
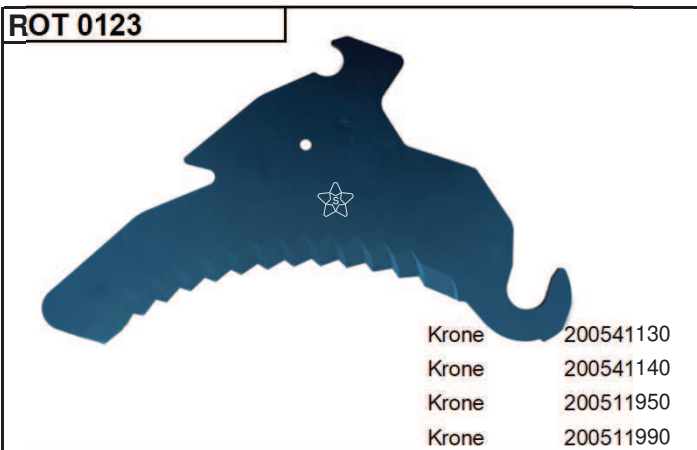
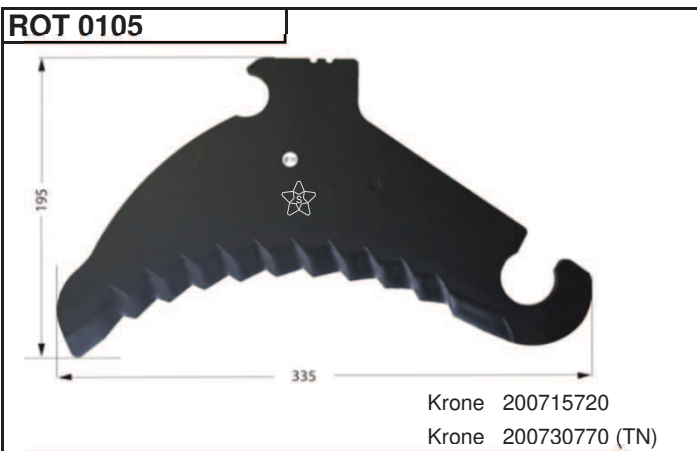
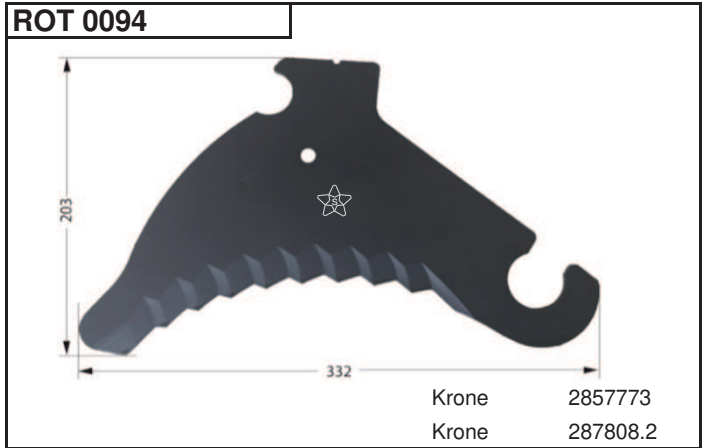



**COLTELLI PER ROTOPRESSE- KNIVES FOR ROUND BALERS**  
**COUTEAUX POUR PRESSES DES BALLEES CYLINDRIQUES - MESSER FÜR BALLENPRESSEN**  
**CUCHILLAS ROTOEMPACADORA - НОЖИ ДЛЯ ПРЕСС-ПОДБОРЩИКА**

Codice

Adattabili a:

Codice

Adattabili a:

**ROT 0083**



**ROT 0086**



**ROT 0110**



**ROT 0050**



**ROT 0055**



**ROT 0087**



**ROT 0088**



**ROT 0119**

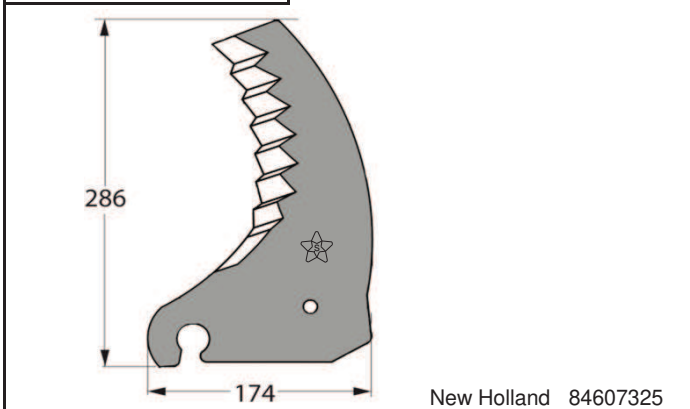

**COLTELLI PER ROTOPRESSE- KNIVES FOR ROUND BALERS**  
**COUTEAUX POUR PRESSES DES BALLEES CYLINDRIQUES - MESSER FÜR BALLENPRESSEN**  
**CUCHILLAS ROTOEMPACADORA - НОЖИ ДЛЯ ПРЕСС-ПОДБОРЩИКА**

Codice

Adattabili a:

Codice

Adattabili a:

**ROT 0103**

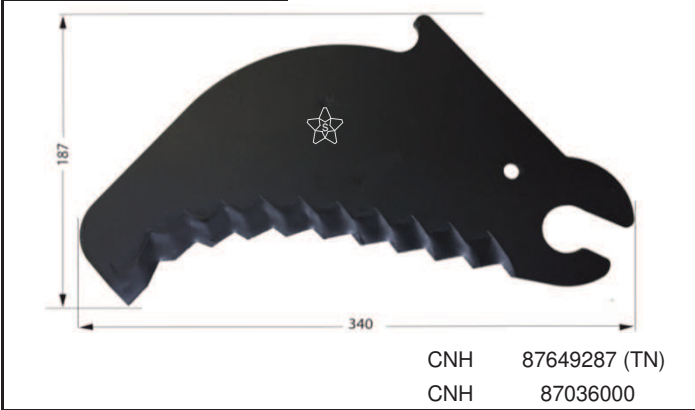

**ROT 0052**

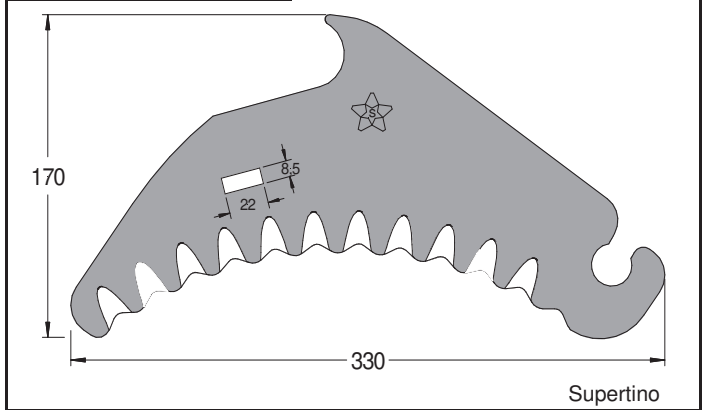

**ROT 0074**



**ROT 0075**



**ROT 0082**



**ROT 0114**

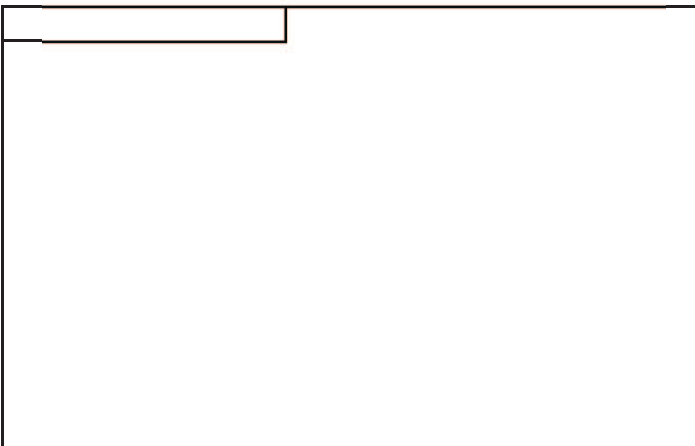

**COLTELLI PER AUTOCARICANTI - LOADING TRAILERS**  
**COUTEAUX POUR REMORQUES AUTOCHARGEUSES - MESSER FÜR LADEWAGEN**  
**CUCHILLAS AUTOCARGADORES - САМОЗАГРУЗОЧНОЙ МАШИНЫ**

Codice

Adattabili a:

Codice

Adattabili a:

**ROT 0089**

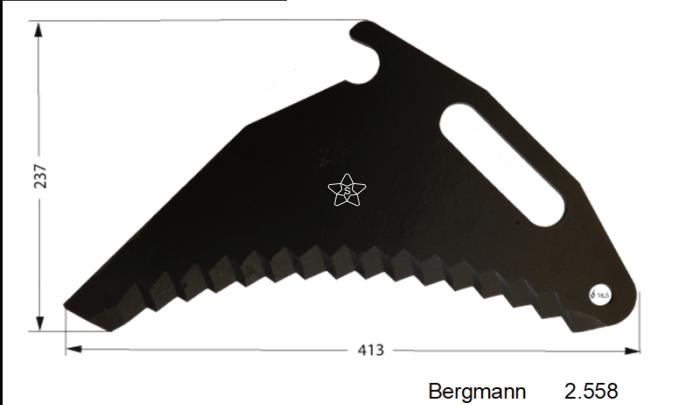

**ROT 0090**



**ROT 0091**



**ROT 0057**

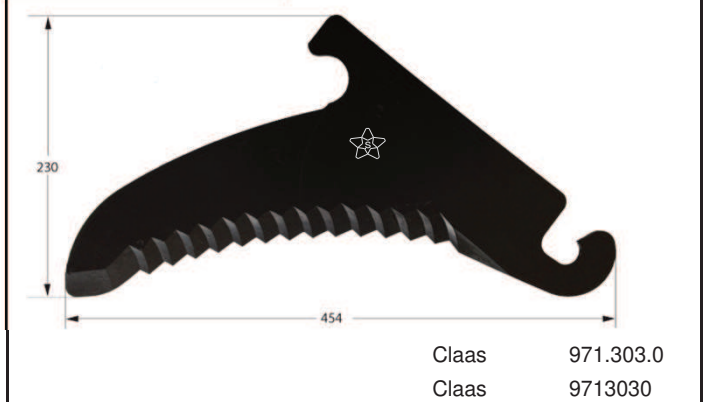

**ROT 0058**



**ROT 0064**



**ROT 0066**

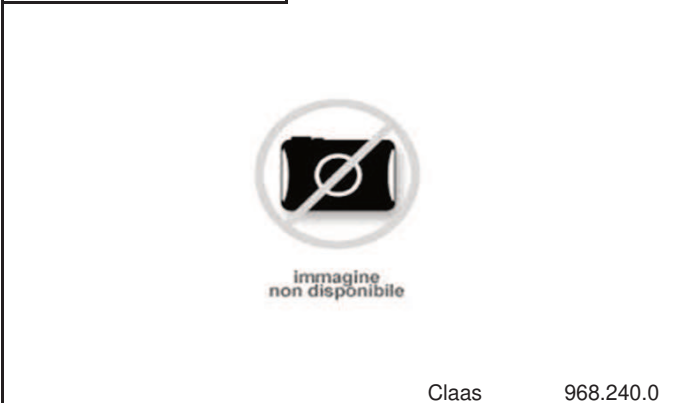

**ROT 0073**



**COLTELLI PER AUTOCARICANTI - LOADING TRAILERS**  
**COUTEAUX POUR REMORQUES AUTOCHARGEUSES - MESSER FÜR LADEWAGEN**  
**CUCHILLAS AUTOCARGADORES - САМОЗАГРУЗОЧНОЙ МАШИНЫ**

Codice

Adattabili a:

Codice

Adattabili a:

**ROT 0092**



**ROT 0059**

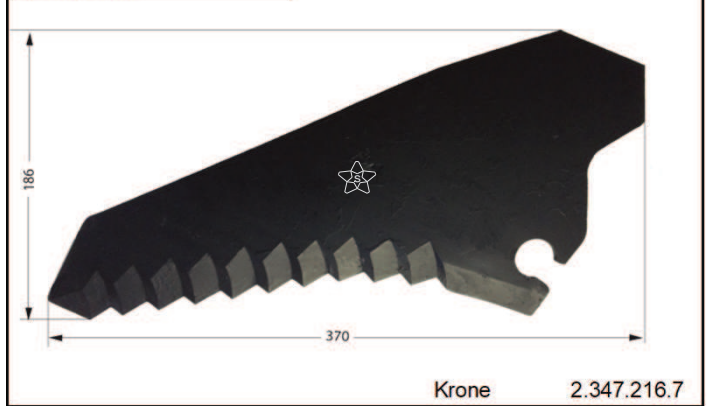

**ROT 0060**

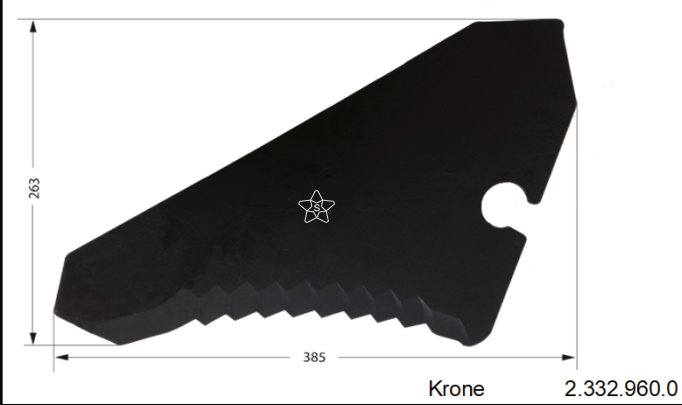

**ROT 0061**



**ROT 0062**

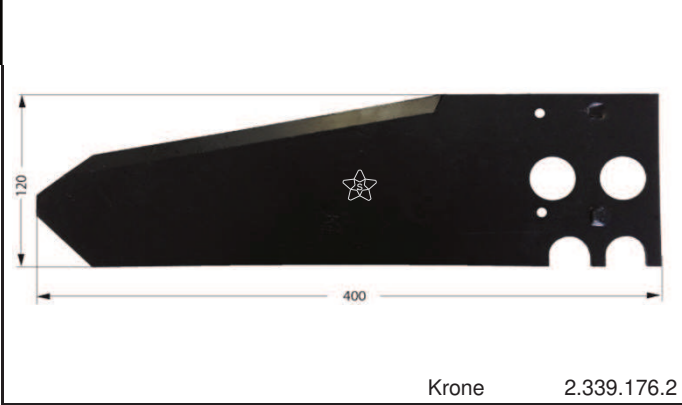

**ROT 0063**

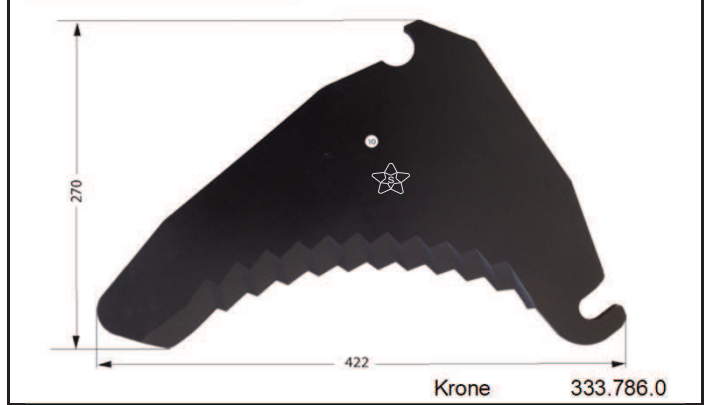

**ROT 0095 A**

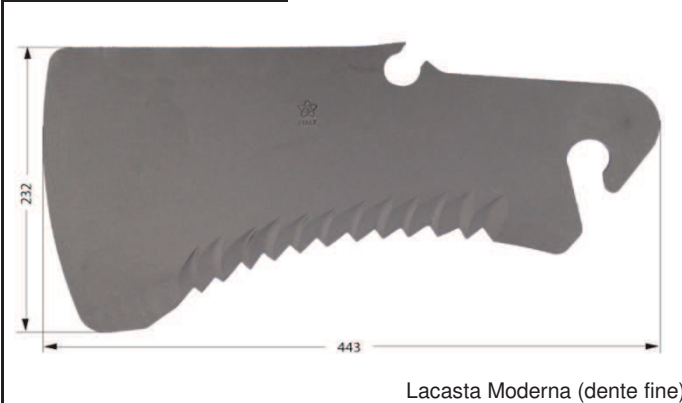

**ROT 0095 B**



**COLTELLI PER AUTOCARICANTI - LOADING TRAILERS**  
**COUTEAUX POUR REMORQUES AUTOCHARGEUSES - MESSER FÜR LADEWAGEN**  
**CUCHILLAS AUTOCARGADORES - САМОЗАГРУЗОЧНОЙ МАШИНЫ**

Codice

Adattabili a:

Codice

Adattabili a:

**ROT 0076**

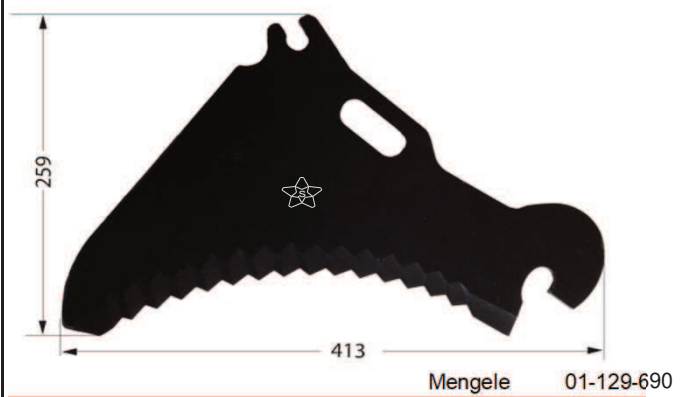

**ROT 0077**



**ROT 0078**



**ROT 0056**

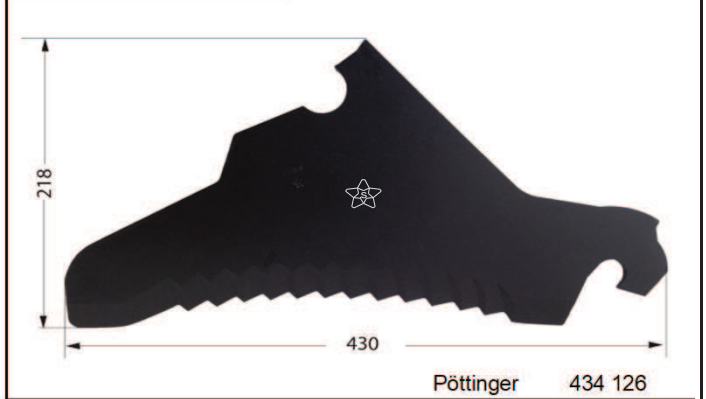

**ROT 0068**



**ROT 0069**



**ROT 0070**

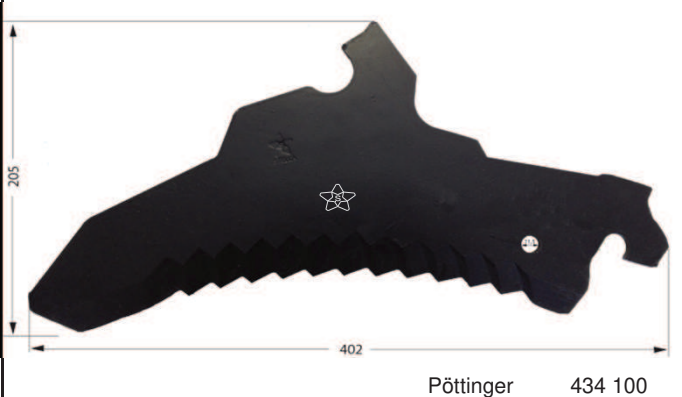

**ROT 0116**



**COLTELLI PER AUTOCARICANTI - LOADING TRAILERS**  
**COUTEAUX POUR REMORQUES AUTOCHARGEUSES - MESSER FÜR LADEWAGEN**  
**CUCHILLAS AUTOCARGADORES - САМОЗАГРУЗОЧНОЙ МАШИНЫ**

Codice

Adattabili a:

Codice

Adattabili a:

**ROT 0097**



**ROT 0099**



**ROT 0102**



**ST 0030**

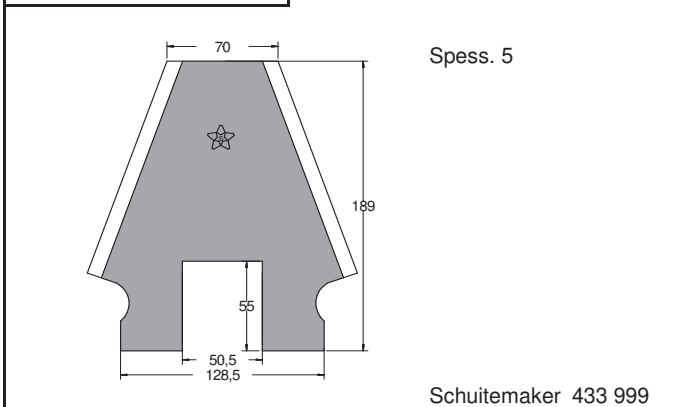

**ST 0031**

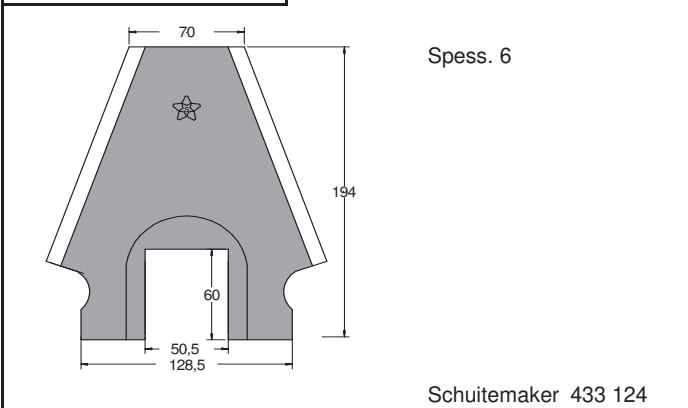

**ST 0032**

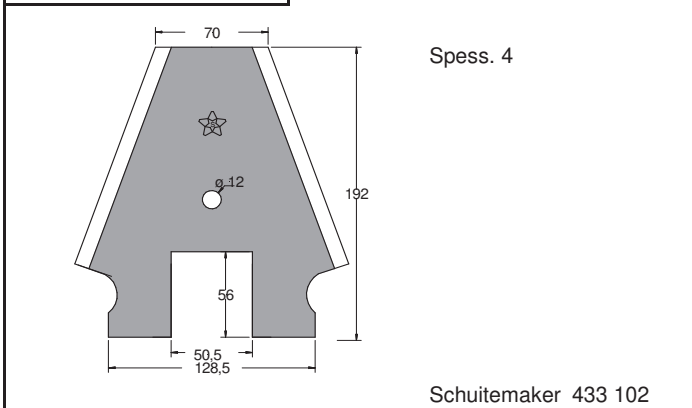

**ROT 0098**



**ROT 0093**



**COLTELLI PER AUTOCARICANTI - LOADING TRAILERS**  
**COUTEAUX POUR REMORQUES AUTOCHARGEUSES - MESSER FÜR LADEWAGEN**  
**CUCHILLAS AUTOCARGADORES - САМОЗАГРУЗОЧНОЙ МАШИНЫ**

Codice

Adattabili a:

Codice

Adattabili a:

ROT 0122

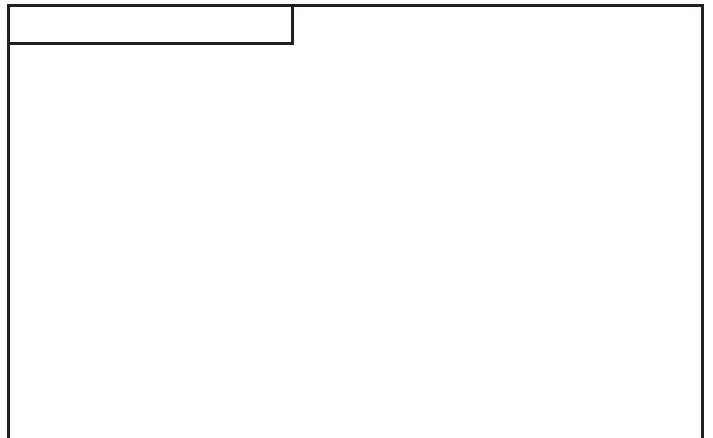
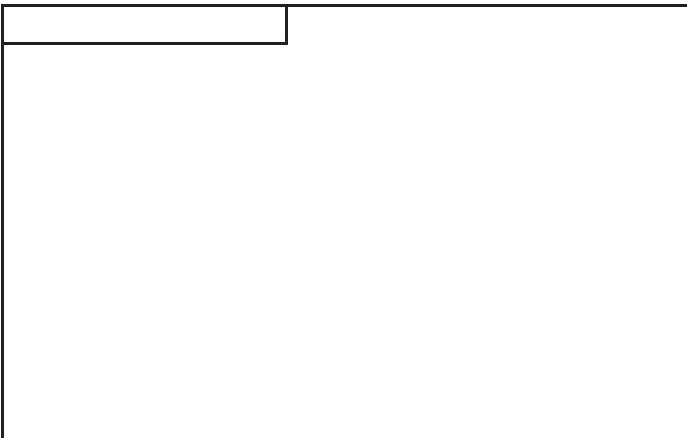
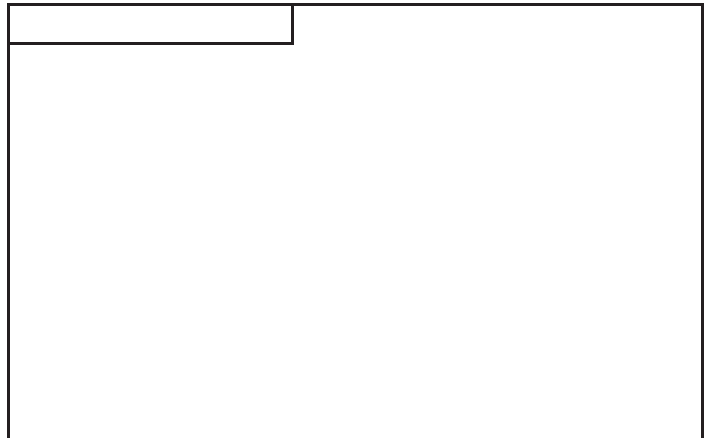
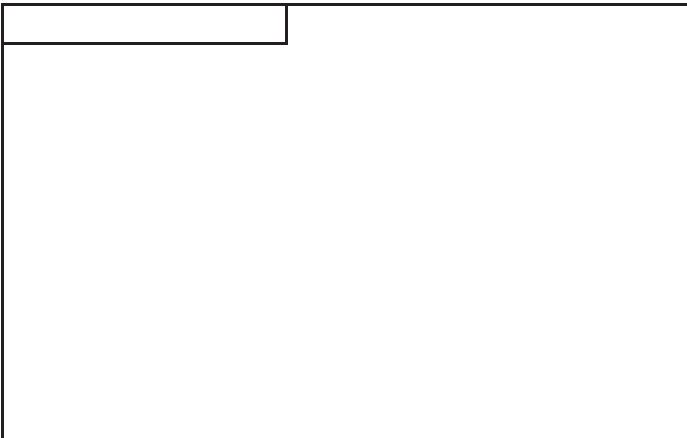
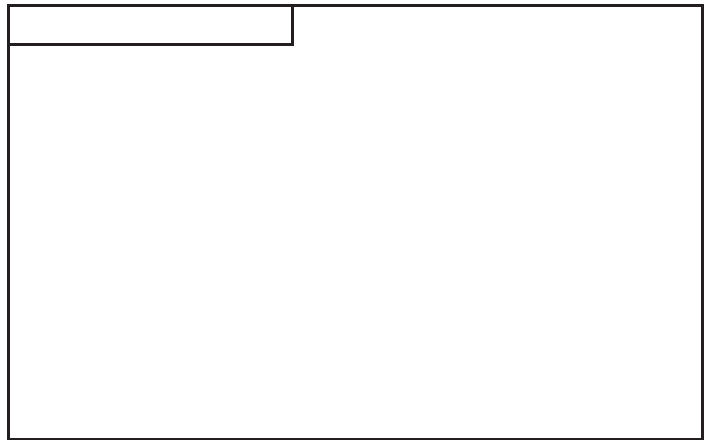
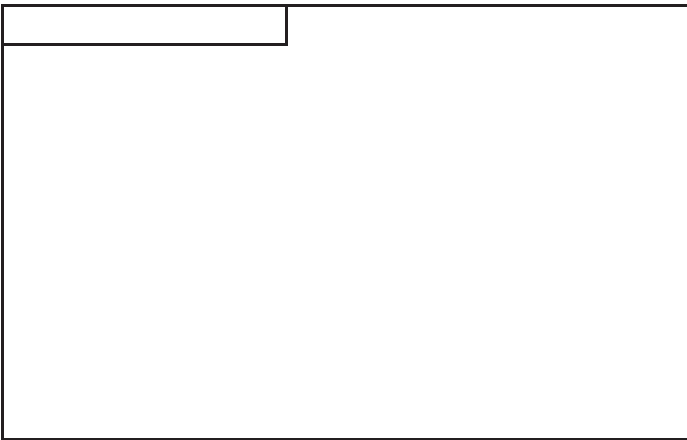
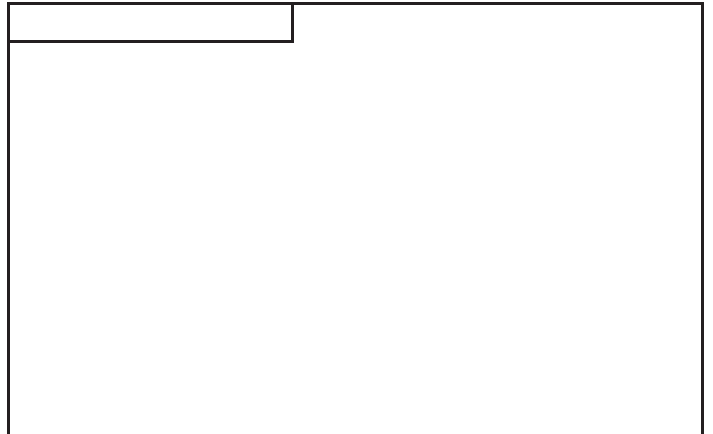
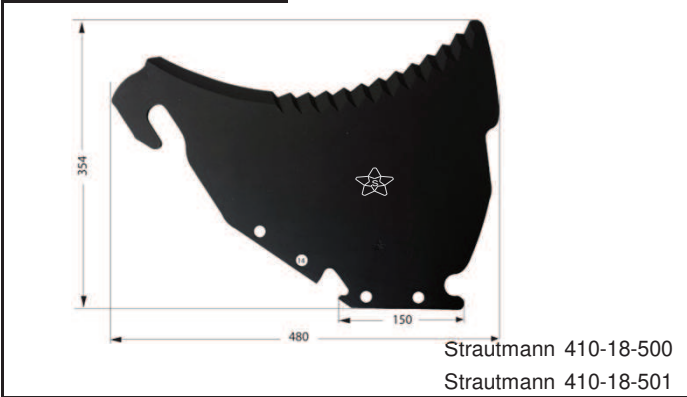

**COLTELLI PER AUTOCARICANTI - LOADING TRAILERS**  
**COUTEAUX POUR REMORQUES AUTOCHARGEUSES - MESSER FÜR LADEWAGEN**  
**CUCHILLAS AUTOCARGADORES - САМОЗАГРУЗОЧНОЙ МАШИНЫ**

Codice

Adattabili a:

Codice

Adattabili a:

--	--

--	--

--	--

--	--

--	--

--	--

--	--

--	--





# PIASTRINE

[www.stellalame.com](http://www.stellalame.com)



**PIASTRINE - PLAQUES**  
**FINGER PLATTEN - PLAQUES - ЧИСТЯЩИЕ ПЛАСТИНЫ**

Codice

Adattabili a:

Codice

Adattabili a:

**SS 220 A**

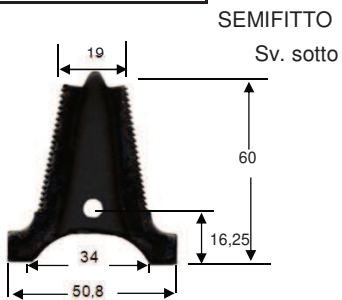

Gaspardo 2002477.1

**246 F**

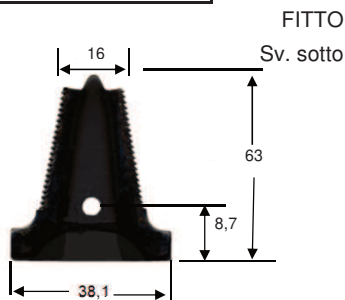

Bcs 58002355.5  
 Bedogni - Olimpia  
 Bertolini

**246 FS**

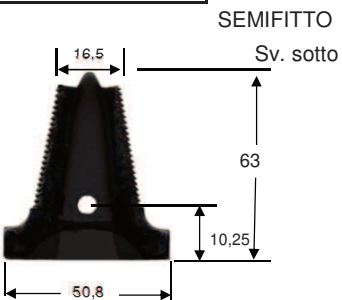

Bcs 58002477.1

**LF 41**

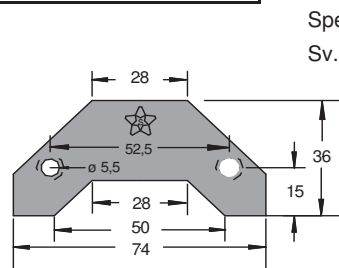

Laverda 3023363

**1250**

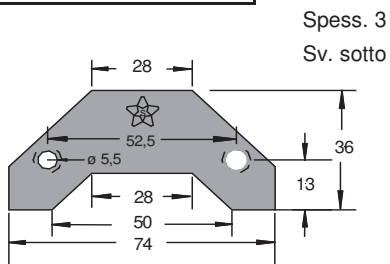

**1250 R**

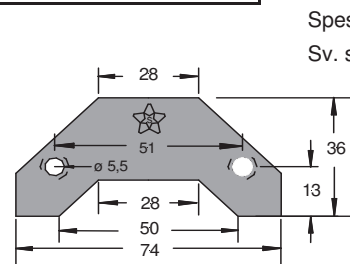

Gaspardo G319

**GS 1395**

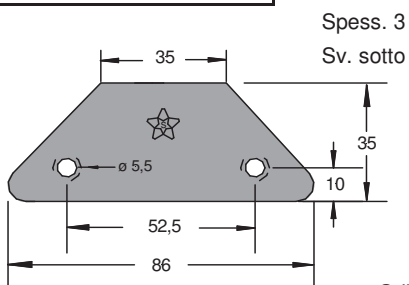

Gribaldi & Salvia 1395

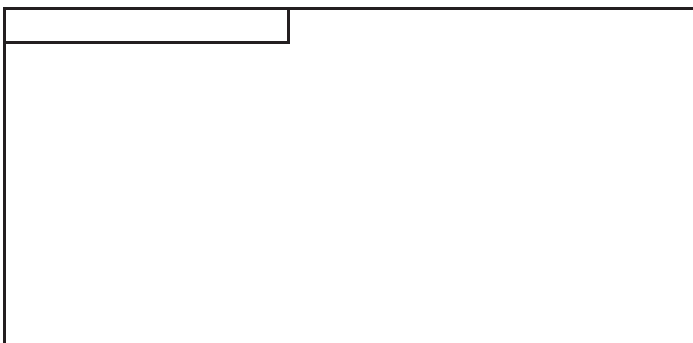
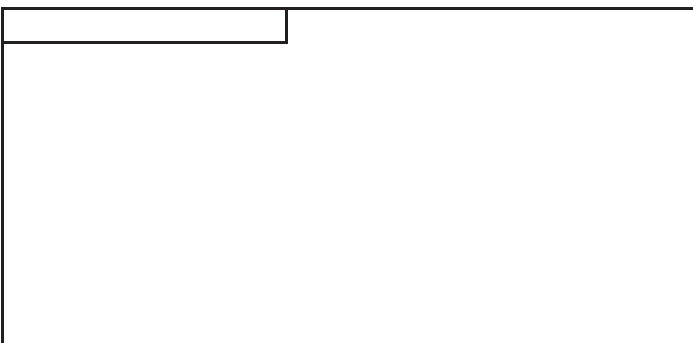

# LAME PER DECESPUGLIATORI

[www.stellalame.com](http://www.stellalame.com)



**LAME PER DECESPUGLIATORI - BLADES FOR BRUSH CUTTER**  
**FREISCHNEIDER MESSER - LAMES POUR DEBROUSSAILLEUSES**  
**DESBROZADORAS - ЛЕЗВИЯ ДЛЯ МОТОКОС**

Codice:

DCP-ROM	Diametro	Foro	Spessore
	255	25,4	1,5
	300	25,4	1,5
	255	25,4	2,5
	300	25,4	2,5
	320	25,4	2,5

DCP-DS3P	Diametro	Foro	Spessore
	255	25,4	1,5

DCP-3P	Diametro	Foro	Spessore
	255	25,4	1,5
	255	25,4	2,5
	300	25,4	2,5

DCP-DS3	Diametro	Foro	Spessore
	200	25,4	1,5
	230	25,4	1,5
	255	25,4	1,5

DCP-DS4	Diametro	Foro	Spessore
	200	25,4	1,5
	230	25,4	1,5
	255	25,4	1,5

DCP-DS8P	Diametro	Foro	Spessore
	200	25,4	1,5
	230	25,4	1,5
	255	25,4	1,5

DCP-DS22P	Diametro	Foro	Spessore
	255	25,4	1,5

232 L TA	Diametro	Foro	Spessore
	-	8,2	2,5



# KIT LAME PER ROBOT AUTOMATICI

[www.stellalame.com](http://www.stellalame.com)



**KIT LAME PER ROBOT AUTOMATICI - KIT BLADES FOR AUTOMATIC ROBOTS**  
**MESSERKLINGEN ROBOT MIT SCHRAUBEN - LAMES POUR ROBOTS AUTOMATIQUES**  
**KIT CUCHILLAS PARA ROBOT - КОМПЛЕКТ ЛЕЗВИЙ ДЛЯ РОБОТА ГАЗОНОКОСИЛКИ**

Codice:

Adattabili a:

KLR 577606402



NEW

Automower Husqvarna (kit lame + viti)

577606402  
577606403  
577606506  
577606503  
577606602

535138701  
535138702  
535138703  
535138801  
535138802  
505127801  
505127802

Le lame del presente catalogo sono adattabili alle marche indicate. I codici e le marche sono solo specificate per fini comparativi e di adattabilità.



# LAME COMPLETE STELLA PER FALCIATRICI

[www.stellalame.com](http://www.stellalame.com)



**LAME COMPLETE PER FALCIATRICI - COMPLETE MOWERS KNIFE**  
**MÄHBALKEN - LAMES COMPLÈTES**  
**BARRAS DE CUCHILLAS - СЕКЦИОНАЛЬНЫЕ НОЖИ ДЛЯ КОСИЛКИ**



**Adattabili BCS**

<b>Codice</b> <b>Code</b>	<b>Rif. Originale</b> <b>Original code</b>	<b>Serie</b> <b>Series</b>	<b>N° Sezioni/denti</b> <b>N° sections/fingers</b>	<b>Tipo sezioni/denti</b> <b>Type sections/fingers</b>	<b>Lunghezza</b> <b>Length</b> (Metri / Meters)	<b>Note</b> <b>Notes</b>
<b>SLC 0010</b>	58027092	Duplex	24	27096 S sv.	1,80	Lama con sezioni
<b>SLC 0020</b>	58027093	Duplex	28	27096 S sv.	2,10	Lama con sezioni
<b>SLC 0030</b>	58028911	Duplex Gold	22	28096 S sv.	1,68	Lama con sezioni
<b>SLC 0040</b>	58028910	Duplex Gold	24	28096 S sv.	1,82	Lama con sezioni
<b>SLC 0050</b>	58028912	Duplex Gold	28	28096 S sv.	2,12	Lama con sezioni
<b>SLC 0060</b>	58028914	Duplex Gold	32	28096 S sv.	2,42	Lama con sezioni
<b>SLC 0070</b>	59020716	622	17	212 SF	1,27	Lama con sezioni
<b>SLC 0080</b>	59020688	622	19	212 SF	1,45	Lama con sezioni
<b>SLC 0085</b>	59020717	622	21	212 SF	1,60	Lama con sezioni
<b>SLC 0090</b>	59048926 59058790	Barra Europa Barra Europa rinforzata	19 19	59015 S sv. 50696 S sv.	1,00 1,00	Lama con sezioni
<b>SLC 0100</b>	59048909 59058791	Barra Europa Barra Europa rinforzata	23 23	59015 S sv. 50696 S sv.	1,15 1,15	Lama con sezioni
<b>SLC 0110</b>	59048906 59058792	Barra Europa Barra Europa rinforzata	27 27	59015 S sv. 50696 S sv.	1,35 1,35	Lama con sezioni
<b>SLC 0111</b>	59058728	Barra Laser / BF 2011	19	58716	1,00	Lama con sezioni
<b>SLC 0112</b>	59058739	Barra Laser / BF 2011	23	58716	1,15	Lama con sezioni
<b>SLC 0113</b>	59058740	Barra Laser / BF 2011	27	58716	1,35	Lama con sezioni





**LAME COMPLETE PER FALCIATRICI - COMPLETE MOWERS KNIFE**  
**MÄHBALKEN - LAMES COMPLÈTES**  
**BARRAS DE CUCHILLAS - СЕКЦИОНАЛЬНЫЕ НОЖИ ДЛЯ КОСИЛКИ**



**Adattabili GASPARDO**

<b>Codice</b> <b>Code</b>	<b>Rif. Originale</b> <b>Original code</b>	<b>Serie</b> <b>Series</b>	<b>N° Sezioni/denti</b> <b>N° sections/fingers</b>	<b>Tipo sezioni/denti</b> <b>Type sections/fingers</b>	<b>Lunghezza</b> <b>Length</b> (Metri / Meters)	<b>Note</b> <b>Notes</b>
<b>SLC 0120</b>	21120049	FB-925 / 925 S	24	88x3 S f.5,5 sv.	1,75	Lama con sezioni
<b>SLC 0130</b>	21120102	FB-925 / 925 S	28	88x3 S f.5,5 sv.	2,05	Lama con sezioni
<b>SLC 0140</b>	21120053	FB-925 / 925 S	12	21120066	1,75	Lama con denti
<b>SLC 0150</b>	21120106	FB-925 / 925 S	14	21120066	2,05	Lama con denti
<b>SLC 0160</b>	21120240	FB-940	24	88x3 S f.6,25 sv.	1,75	Lama con sezioni
<b>SLC 0170</b>	21120241	FB-940	28	88x3 S f.6,25 sv.	2,05	Lama con sezioni
<b>SLC 0180</b>	21120256 13013861	FB-940	12	21120268	1,75	Lama con denti
<b>SLC 0190</b>	21120257 13013871	FB-940	14	21120268	2,05	Lama con denti
<b>SLC 0200</b>	13013580	FBR	24	88x3 S f.6,25 sv.	1,75	Lama con sezioni
<b>SLC 0210</b>	13013590	FBR	28	88x3 S f.6,25 sv.	2,05	Lama con sezioni
<b>SLC 0220</b>	13013770	FBR	12	13013270	1,75	Lama con denti
<b>SLC 0230</b>	13013780	FBR	14	13013270	2,05	Lama con denti
<b>SLC 0232</b>	13013772	FBR	12	13013270 / 13014220	1,75	Lama con denti
<b>SLC 0234</b>	13013782	FBR	14	13013270 / 13014220	2,05	Lama con denti



**LAME COMPLETE PER FALCIATRICI - COMPLETE MOWERS KNIFE**  
**MÄHBALKEN - LAMES COMPLÈTES**  
**BARRAS DE CUCHILLAS - СЕКЦИОНАЛЬНЫЕ НОЖИ ДЛЯ КОСИЛКИ**



**Adattabili GASPARDO**

Codice Code	Rif. Originale Original code	Serie Series	N° Sezioni/denti N° sections/fingers	Tipo sezioni/denti Type sections/fingers	Lunghezza Length (Metri / Meters)	Note Notes
<b>SLC 0236</b>	13013670	FBR	24	1313540/50	1,75	Lama con sez. doppie
<b>SLC 0238</b>	13013680	FBR	28	1313540/50	2,05	Lama con sez. doppie

**Adattabili GRIBALDI & SALVIA**

<b>SLC 0240</b>	.017	Superior	24	89x3 S f.5,5 sv. sopra	1,82	Lama con sezioni
<b>SLC 0250</b>	.017	Superior	28	89x3 S f.5,5 sv. sopra	2,12	Lama con sezioni
<b>SLC 0260</b>	.016	Superior	12	087-088	1,82	Lama con denti
<b>SLC 0270</b>	.016	Superior	14	087-088	2,12	Lama con denti

**Adattabili BEDOGNI**

<b>SLC 0280</b>	12280	Olimpia	17	212 SF	1,27	Lama con sezioni
<b>SLC 0290</b>	12280	Olimpia	19	212 SF	1,40	Lama con sezioni

**Adattabili BERTOLINI**

<b>SLC 0300</b>	BRF58.124D-125-126		17	212 SF	1,27	Lama con sezioni
<b>SLC 0310</b>	BRF58.124D-125-126		19	212 SF	1,40	Lama con sezioni

**ALTRE MARCHE**

*SU RICHIESTA*



# LAME COMPLETE STELLA PER MIETITREBBIA

[www.stellalame.com](http://www.stellalame.com)



**LAME COMPLETE PER MIETITREBBIA - COMPLETE KNIFE**  
**MÄHBALKEN - LAMES COMPLÈTES - BARRAS DE CUCHILLAS -**  
**СЕКЦИОНАЛЬНЫЕ НОЖИ ДЛЯ ЗЕРНОУБОРОЧНЫХ КОМБАЙНОВ**



**Adattabili LAVERDA**

<b>Codice</b> <b>Code</b>	<b>Rif. Originale</b> <b>Original code</b>	<b>Serie</b> <b>Series</b>	<b>N° Sezioni/denti</b> <b>N° sections/fingers</b>	<b>Tipo sezioni/denti</b> <b>Type sections/fingers</b>	<b>Lunghezza</b> <b>Length</b> (Metri / Meters)	<b>Note</b> <b>Notes</b>
<b>SLC 1000</b>	300114585	-	43	242 S	3,10	-
<b>SLC 1005</b>	300114586	-	49	242 S	3,60	-
<b>SLC 1010</b>	300114587	-	57	242 S	4,20	-
<b>SLC 1020</b>	300114588	-	65	242 S	4,80	-
<b>SLC 1030</b>	300114589	-	73	242 S	5,40	-
<b>SLC 1040</b>	300114590	-	81	242 S	6,20	-
<b>SLC 1050</b>	300114591	-	89	242 S	6,60	-
<b>SLC 1055</b>	320900050	-	42	343 SR f.6,8	3,10	-
<b>SLC 1060</b>	321220050	-	49	343 SR f.6,8	3,60	-
<b>SLC 1070</b>	321220150	-	53	343 SR f.6,8	3,90	-
<b>SLC 1080</b>	321220250	-	57	343 SR f.6,8	4,20	-
<b>SLC 1090</b>	321220350	-	65	343 SR f.6,8	4,80	-
<b>SLC 1100</b>	321220450	-	73	343 SR f.6,8	5,40	-



**LAME COMPLETE PER MIETITREBBIA - COMPLETE KNIFE  
MÄHBALEN - LAMES COMPLÈTES - BARRAS DE CUCHILLAS -  
СЕКЦИОНАЛЬНЫЕ НОЖИ ДЛЯ ЗЕРНОУБОРОЧНЫХ КОМБАЙНОВ**



**Adattabili LAVERDA**

<b>Codice Code</b>	<b>Rif. Originale Original code</b>	<b>Serie Series</b>	<b>N° Sezioni/denti N° sections/fingers</b>	<b>Tipo sezioni/denti Type sections/fingers</b>	<b>Lunghezza Length (Metri / Meters)</b>	<b>Note Notes</b>
<b>SLC 1110</b>	321220550	-	81	343 SR f.6,8	6,00	-
<b>SLC 1120</b>	321220650	-	89	343 SR f.6,8	6,60	-
<b>SLC 1130</b>	321220750	-	101	343 SR f.6,8	7,60	-
<b>SLC 1140</b>	322704300/V	-	57	222 20	4,20	-
<b>SLC 1150</b>	322704400/V	-	65	222 20	4,80	-
<b>SLC 1160</b>	322704500/V	-	73	222 20	5,40	-
<b>SLC 1170</b>	322704600/V	-	81	222 20	6,00	-
<b>SLC 1180</b>	322704700/V	-	89	222 20	6,60	-
<b>SLC 1190</b>	322704000	-	13	222 20		Spezzone lama centrale
<b>SLC 1200</b>	322704100	-	22	222 20		Spezzone lama finale
<b>SLC 1210</b>	322704200	-	24	222 20		Spezzone lama iniziale
<b>SLC 1220</b>	322709500	-	14	222 20		Spezzone lama finale
<b>SLC 1230</b>	322707150	-	3	222 20		Kit giunzione



**LAME COMPLETE PER MIETITREBBIA - COMPLETE KNIFE  
MÄHBALKEN - LAMES COMPLÈTES - BARRAS DE CUCHILLAS -  
СЕКЦИОНАЛЬНЫЕ НОЖИ ДЛЯ ЗЕРНОУБОРОЧНЫХ КОМБАЙНОВ**







**Adattabili LAVERDA**

Codice Code	Rif. Originale Original code	Serie Series	N° Sezioni/denti N° sections/fingers	Tipo sezioni/denti Type sections/fingers	Lunghezza Length (Metri / Meters)	Note Notes
<b>SLC 1300</b>	3113011520	-	55	242 S	4,20	Testa lama 311301110
<b>SLC 1310</b>	3113011530	-	63	242 S	4,80	Testa lama 311301110
<b>SLC 1400</b>	300032600	-	30	242 S	2,30	-
<b>SLC 1410</b>	300117667	-	42	242 S	3,10	-
<b>SLC 1420</b>	300114783	-	53	242 S	3,90	-

**LAME COMPLETE PER POMODORO**

<b>SLC 0410</b>	-	-	18	ST 6000 ZN sv. sotto	1,635	-
<b>SLC 0420</b>	-	-	20	ST 6000 ZN sv. sotto	1,655	-
<b>SLC 0430</b>	-	-	22	ST 6000 ZN sv. sotto	1,900	-

**Teste lama per mietitrebbia**

<b>STL 1000</b>	311458660	Laverda		Foro 5,5	-
<b>STL 1010</b>	3212199510	Laverda		Foro 6,5	-
<b>STL 1020</b>	322702950 323425450	Laverda		-	-
<b>STL 1030</b>	80753862	New Holland		-	-

**Teste lama per falciatrici**

<b>STL 2000</b>	56358708	BCS			Barra laser
-----------------	----------	-----	--	--	-------------



# Nuovo dente doppio **UNIVERSALE**

**Forgiato**

[www.stellalame.com](http://www.stellalame.com)



- **Facile da montare e smontare**

il dente doppio UNIVERSALE viene montato senza dover rimuovere la barra di taglio dalla testata e non necessita del premilama addizionale grazie alla sua innovativa piastrina incorporata nel pezzo

- **Guida precisa della barra di taglio**

L'utilizzo di acciaio forgiato determina misure uniformi del dente UNIVERSALE che riducono la resistenza della barra di taglio durante il movimento garantendo un taglio ottimale



- **100% intercambiabile**

intercambiabile sulle principali testate mietitrebbia John Deere, Agco, Laverda, Fendt, Rostselmash, Deutz Fahr e su tutte le applicazioni Sch

Adattabile alla nuova cutting unit Stella Testa rossa

- **Maggiore pulizia della testata**

grazie al suo innovativo design non si accumulano detriti vegetali all'interno del dente e la barra di taglio si mantiene sempre pulita

- **Trattato termicamente**

per prestazioni più elevate e durata superiore

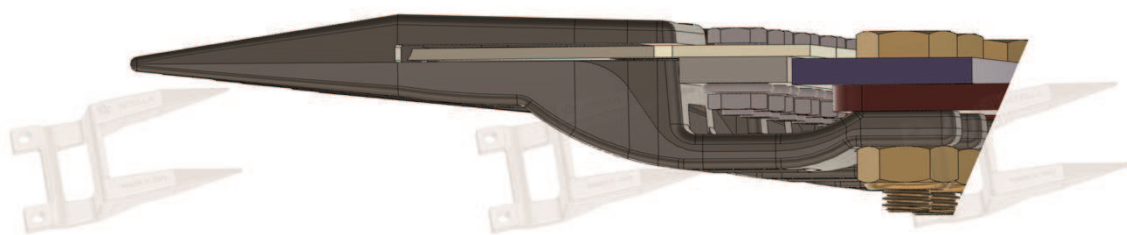

codice prodotto STDM 01 UNIVERSALE

**Prodotto brevettato**





**DENTI PER MIETITREBBIA - GUARDS FOR HARVESTER**  
**MÄHFINGER FÜR MAHDRESCHER - DOIGTS POUR MOISSONNEUSES BATTEUSE**  
**DEDO COSECHADORA**

Codice

Adattabili a:

Codice

Adattabili a:

**STDM 01 UNIVERSALE**



Forgiato

Sch 410100001  
 Sch 16500.01  
 Deutz Fahr 6503514  
 Laverda 322702450  
 John Deere Z11785  
 Agco 71386906  
 Massey Ferguson

**NEW**

**DM 1**



Deutz Fahr 6503514  
 Laverda 322702450  
 John Deere Z11785  
 Agco 71386906  
 Sch 410100001  
 Sch 16500.01  
 Massey Ferguson

**STDM 02 UNIVERSALE OPEN**



Forgiato

Sch 410300041  
 Sch 10701.01  
 Laverda 322702550  
 John Deere AH143573  
 Deutz Fahr  
 Agco 71386905/06  
 Massey Ferguson

**NEW**

**DM 2**



Sch 410300041  
 Sch 10701.01  
 Laverda 322702550  
 John Deere AH143573  
 Deutz Fahr  
 Agco 71386905/06  
 Massey Ferguson

**DM 3**



New Holland 80379720

**DM 4**

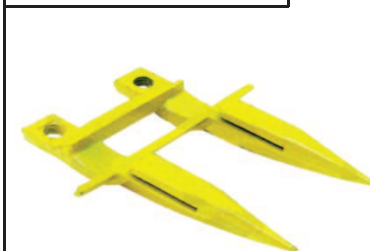

New Holland 80916328

**DM 5**



Laverda 321115050

**DM 6**

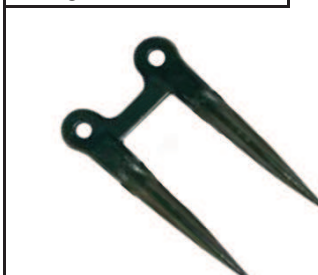

Laverda 301896130

**DM 7**



John Deere Z11228  
 John Deere H61954

**DM 11**



Deutz Fahr 111306023600  
 (06236756)



**DENTI PER MIETITREBBIA - GUARDS FOR HARVESTER**  
**MÄHFINGER FÜR MAHDRESCHER - DOIGTS POUR MOISSONNEUSES BATTEUSE**  
**DEDO COSECHADORA**

Codice

Adattabili a:

Codice

Adattabili a:

<b>DM 12</b>		Claas 676235 Claas LEXION 626295
--------------	---	-------------------------------------

<b>DM 13</b>		Massey Ferguson 609993M91
--------------	--	---------------------------

**DENTI PER FALCIATRICI - GUARDS FOR MOWER**  
**MÄHFINGER FÜR MAHMASCHINEN - DOIGTS POUR FAUCHEUSES**  
**DEDOS PARA SEGADORAS**

Codice

Adattabili a:

Codice

Adattabili a:

<b>DF 1</b>		Semifitto  BCS 59027624
-------------	---	-------------------------------

<b>DF 2</b>		Fitto  BCS 59027622
-------------	--	---------------------------

<b>DF 3</b>		Gaspardo 21120066 (f.5,5) Gaspardo 21120268 (f.6,25) G&S Superior
-------------	---	---

<b>DF 4</b>		Smontabile  Gaspardo 13013270 G&S Superior
-------------	--	---

<b>DF 7</b>		New Holland 257635 Hesston 049312
-------------	---	--------------------------------------

--	--	--



# LAME SPECIALI

Grazie alla pluriennale esperienza nel settore dei sistemi di taglio Stella studia e realizza numerosi tipi di lame ad alte prestazioni. Sono infatti prodotte negli stabilimenti Stella le lame speciali montate nei vari settori industriali.

L'ufficio Engineering di Stella collabora direttamente con gli uffici tecnici di numerose società italiane ed internazionali al fine di realizzare prodotti di altissima qualità per i più diversi impieghi: agricoltura, giardinaggio, viticoltura, riciclaggio.

La performance per Stella viene prima di tutto.





STELLA srl  
Via Badia 30  
25060 Cellatica (Brescia)  
Italia  
Phone +39 030 3732311  
Fax. +39 030 3738393  
stella@stellalame.com

[www.stellalame.com](http://www.stellalame.com)

 made in Italy